

# Plumber General II

(Job Role)

Qualification Pack: Ref. Id. PSC/Q0110

Sector: Plumbing

Textbook for Class XI



विद्यया ऽ मृतमश्नुते



एन सी ई आर टी  
NCERT

राष्ट्रीय शैक्षिक अनुसंधान और प्रशिक्षण परिषद्  
NATIONAL COUNCIL OF EDUCATIONAL RESEARCH AND TRAINING

ISBN 978-93-5292-149-2

**First Edition**

June 2019 Ashadha 1941

PD 5T SU

© **National Council of Educational  
Research and Training, 2019**

₹ 115.00

Printed on 80 GSM paper with NCERT  
watermark

Published at the Publication Division  
by the Secretary, National Council of  
Educational Research and Training,  
Sri Aurobindo Marg, New Delhi 110 016  
and printed at Raas Technoprint,  
A-93, Sector-65, Noida-201 301 (UP)

**ALL RIGHTS RESERVED**

- ❑ No part of this publication may be reproduced, stored in a retrieval system or transmitted, in any form or by any means, electronic, mechanical, photocopying, recording or otherwise without the prior permission of the publisher.
- ❑ This book is sold subject to the condition that it shall not, by way of trade, be lent, re-sold, hired out or otherwise disposed off without the publisher's consent, in any form of binding or cover other than that in which it is published.
- ❑ The correct price of this publication is the price printed on this page. Any revised price indicated by a rubber stamp or by a sticker or by any other means is incorrect and should be unacceptable.

**OFFICES OF THE PUBLICATION  
DIVISION, NCERT**

NCERT Campus  
Sri Aurobindo Marg  
New Delhi 110 016 Phone : 011-26562708

108, 100 Feet Road  
Hosdakere Halli Extension  
Banashankari III Stage  
Bengaluru 560 085 Phone : 080-26725740

Navjivan Trust Building  
P.O.Navjivan  
Ahmedabad 380 014 Phone : 079-27541446

CWC Campus  
Opp. Dhankal Bus Stop  
Panihati  
Kolkata 700 114 Phone : 033-25530454

CWC Complex  
Maligaon  
Guwahati 781 021 Phone : 0361-2674869

**Publication Team**

Head, Publication Division : *M. Siraj Anwar*  
Chief Editor : *Shveta Uppal*  
Chief Production Officer : *Arun Chitkara*  
Chief Business Manager : *Bibash Kumar Das*  
Production Officer : *Abdul Naim*

**Cover and Layout**

*DTP Cell, Publication Division*

## FOREWORD

The National Curriculum Framework 2005 (NCF 2005) recommends bringing work and education into the domain of the curricular, infusing it in all areas of learning while giving it an identity of its own at relevant stages. It explains that work transforms knowledge into experience and generates important personal and social values such as self-reliance, creativity and cooperation. Through work, one learns to find one's place in the society. It is an educational activity with an inherent potential for inclusion. Therefore, an experience of involvement in productive work in an educational setting will make one appreciate the worth of social life and what is valued and appreciated in society. Work involves interaction with material or other people (mostly both), thus creating a deeper comprehension and increased practical knowledge of natural substances and social relationships.

Through work and education, school knowledge can be easily linked to learners' life outside the school. This also makes a departure from the legacy of bookish learning and bridges the gap between the school, home, community and the workplace. The NCF-2005 also emphasises on Vocational Education and Training (VET) for all those children who wish to acquire additional skills and/or seek livelihood through vocational education after either discontinuing or completing their school education. VET is expected to provide a 'preferred and dignified' choice rather than a terminal or 'last-resort' option.

As a follow-up of this, the NCERT has attempted to infuse work across the subject areas and also contributed in the development of the National Skill Qualification Framework (NSQF) for the country, which was notified on 27 December 2013. It is a quality assurance framework that organises all qualifications according to levels of knowledge, skills and attitude. These levels, graded from one to ten, are defined in terms of learning outcomes, which the learner must possess regardless of whether they are obtained through formal, non-formal or informal learning. The NSQF sets

common principles and guidelines for a nationally recognised qualification system covering Schools, Vocational Education and Training Institutions, Technical Education Institutions, Colleges and Universities.

It is under this backdrop that Pandit Sunderlal Sharma Central Institute of Vocational Education (PSSCIVE), Bhopal, a constituent of the NCERT has developed learning outcomes based modular curricula for the vocational subjects from Classes IX to XII. This has been developed under the Centrally Sponsored Scheme of Vocationalisation of Secondary and Higher Secondary Education of the Ministry of Human Resource Development.

This textbook has been developed as per the learning outcomes based curriculum, keeping in view the National Occupational Standards (NOS) for the job role and to promote experiential learning related to the vocation. This will enable the students to acquire necessary skills, knowledge and attitude.

I acknowledge the contribution of the development team, reviewers and all the institutions and organisations, which have supported in the development of this textbook.

The NCERT would welcome suggestions from students, teachers and parents, which would help us to further improve the quality of the material in subsequent editions.

New Delhi  
June 2018

HRUSHIKESH SENAPATY  
*Director*  
National Council of Educational  
Research and Training

## ABOUT THE TEXTBOOK

Plumber General II is an important job role in the installation and repair of plumbing fittings and fixtures in contractors' segment. This module aims to equip the student with the skills for installation, repair maintenance and servicing of pipes and sanitary fixtures in housing, commercial and institutional set-ups. A Plumber General should be able to work independently on the assignment, and be comfortable in performing laborious work, should be a good listener, good at talking and following instructions, a good team player, result oriented with a positive attitude.

After completing this module of Plumber General II, the student will be able to—

- understand and use the term plumbing
- identify power tools used in plumbing and sanitary fixtures
- install basic plumbing and their maintenance
- repair construction of basic plumbing

On completion of this course, a student can take up a higher level course for a job role in the plumbing sector at the diploma and degree level.

The textbook for the job role of Plumber General II has been developed to impart knowledge and skills through hands-on learning experience, which forms a part of experimental learning. Experimental learning focuses on the learning process for the individual; therefore, the learning activities are student-centred rather than teacher-centred.

The textbook has been developed with the contribution of the subject experts, vocational teachers, industry experts and academicians, for making it a useful and inspiring teaching-learning resource material for the vocational students. Adequate care has been taken to align the contents of the textbook with the National Occupational Standards (NOS) for the job role so that the students acquire the necessary knowledge and skills as per the performance

criteria mentioned in the respective NOS of the Qualification Pack (QP) PSC/Q0110.

1. PSC/N 0101 Installation of basic sanitary fixtures, fittings, related piping and accessories
2. PSC/N 0102 Repair of basic plumbing systems
3. PSC/N 0115 Installation and repair of advanced sanitary fixtures
4. PSC/N 0108 Coordinating with the senior and other working team
5. PSC/N 0109 Maintain a healthy, safe and secure working environment

In this textbook, Unit 1 gives an introduction to plumbing and its importance. Unit 2 focuses on the tools used in plumbing. It includes the various types of manual tool required for carrying out plumbing tasks. Unit 3 deals with the use of power tools. Unit 4 discusses the installation of basic sanitary fittings and fixtures. Unit 5 deals with the repair of leakages in basic fittings and fixtures and Unit 6 discusses about performing various plumbing related operations and procedures.

I hope that this textbook will be useful to the students who will opt for this job role and their teachers. I shall be grateful to receive suggestions and observations from readers which would help in bringing out a revised and improved version of this textbook.

SAURABH PRAKASH

*Professor*

Department of Engineering and Technology  
PSSCIVE, Bhopal

# TEXTBOOK DEVELOPMENT TEAM

## MEMBERS

Abhay Kumar Jha, *Associate Professor*, Department of Civil Engineering, Laxmi Narain College of Technology and Science, Bhopal, Madhya Pradesh, India

Avinash Singh, *Former Consultant*, Department of Engineering and Technology, Pandit Sunderlal Sharma Central Institute of Vocational Education, Bhopal, Madhya Pradesh, India

Gunjan Aneja, *Operations Manager*, Indian Plumbing Skill Council, Okhla Industrial Area, Phase-I, New Delhi, India

Hemant Wadikar, *Lecturer*, Swami Vivekanand Junior College (HSC Vocational), Sindhi Society, Chembur, Mumbai, India

Pooja Sharma, *Vice President*, Indian Plumbing Skill Council, New Delhi, India

Tapas Singh, *Assistant Professor*, Civil Engineering Department, Technocrats Institute of Technology, Bhopal, Madhya Pradesh, India

## MEMBER-COORDINATOR

Saurabh Prakash, *Professor*, Department of Engineering and Technology, Pandit Sunderlal Sharma Central Institute of Vocational Education, Bhopal, Madhya Pradesh, India

## ACKNOWLEDGEMENTS

The National Council of Educational Research and Training (NCERT) expresses its gratitude to the members of the Project Approval Board (PAB) and the officials of the Ministry of Human Resource Development (MHRD), Government of India, for the financial support to the project for development of learning outcome based curricula.

The Council acknowledges the contribution of the members of the Review Committee for sharing their expertise and time. The Council would also like to thank Rajesh Khambayat, *Joint Director*, PSS Central Institute of Vocational Education (PSSCIVE), Bhopal for providing support and guidance in the development of this textbook.

The Council is also grateful to Saroj Yadav, *Professor and Dean* (Academics), and Ranjana Arora, *Professor and Head*, Department of Curriculum Studies, NCERT, for their sincere efforts in coordinating the review workshops for the finalisation of this book.

This textbook would not have been possible without the support of the Indian Plumbing Skill Council (IPSC), New Delhi. We would like to acknowledge and thank IPSC for giving us the permission to use the pictures in this textbook.

We extend our gratitude to all the contributors for selflessly sharing their precious knowledge, acclaimed expertise and valuable time, and positively responding to our request for development of the textbook.

We are thankful to the course coordinator Saurabh Prakash, *Professor*, Department of Engineering and Technology, PSSCIVE, Bhopal, for his untiring efforts towards developing the content for this textbook and also providing photographs used in the textbook. The images used other than these are under Creative Commons License. The contribution of Kuldeep Singh Patel, *Junior Project Fellow*, and Avinash Singh, *Consultant*, Department of Engineering and Technology, PSSCIVE, Bhopal is also acknowledged.

The Council also acknowledges the copyediting and proofreading by Garima Syal, *Editorial Assistant* (Contractual), Publication Division, NCERT. The efforts of Pawan Kumar Barriar, *DTP Operator*, and Naresh Kumar, *DTP Operator* (Contractual), Publication Division, NCERT; Akhilesh Kashiv, *Computer Operator*, Vikas Kumar Kogey, *Graphic Artist* (Contractual) and Pinki Tiwari, *Graphic Designer* (Contractual), PSSCIVE, NCERT, are also acknowledged.



## CONTENTS

<i>Foreword</i>	<i>iii</i>
<i>About the Textbook</i>	<i>v</i>
Unit 1 : Plumbing and related Basic Terms	1
Unit 2 : Tools for Plumbing	15
Unit 3 : Use of Power Tools	27
Unit 4 : Installation of Basic Sanitary Fittings and Fixtures	39
Unit 5 : Repair of Leakages in Basic Fittings and Fixtures	55
Unit 6 : Performing various Plumbing related Operations and Procedures	81
<i>Answer Key</i>	<i>98</i>

## *Do You Know*

According to the 86<sup>th</sup> Constitutional Amendment Act, 2002, free and compulsory education for all children in 6-14 year age group is now a Fundamental Right under Article 21-A of the Constitution.

**EDUCATION IS NEITHER A PRIVILEGE NOR FAVOUR BUT A BASIC HUMAN RIGHT TO WHICH ALL GIRLS AND WOMEN ARE ENTITLED**

*Give Girls  
Their Chance !*



Unit



# Plumbing and related Basic Terms

## INTRODUCTION

Plumbing is a skill which helps in the installation of bathroom and kitchen fittings, laying of new pipelines in buildings and identifying the defects in pipeline. The plumbing system includes two main systems—the water supply and the drainage system. Why is the plumbing system necessary for every construction project? Whether a small or big construction, proper planning and designing of the plumbing system helps in maintaining the hygiene requirements of the occupants and acts as a safeguard against illness. It has been reported that 8 per cent of the total construction cost of the building is marked for plumbing and sanitary work.\*

In order to understand plumbing and its work process, it is important to understand some key terms. A knowledge of these terms will help the Plumber General in the preparation and estimation of one's work and also in understanding the assembly sheet of the plumbing fixtures in the manufacturer's catalogue.

## A

### Air gap

The distance between the lowest point of a water inlet or pipe to a tank and the overflowing level of the tank

\* B.N. Dutta.1997. *Estimating and Costing in Civil Engineering: Theory and Practice*. UBS Publishers' Distributors Ltd., New Delhi.



171121CH01

## NOTES

### AC pipes

Asbestos-Cement pipe used in water distribution systems

### Appliance

A container or apparatus in which water is heated, treated or measured, or in which it is utilised before passing to waste

### Auger

A tool having a rotating helical screw blade used for drilling a hole

### Available head

The head of water available at the point of consideration due to main's pressure or overhead tank or any other source of pressure

## B

### Backflow

It is an unwanted flow of water in the reverse direction. It leads to wastage of water and it is due to leakage or defect in the system.

### Backflow prevention device

This device is fitted in such a way that allows water to flow in one direction but never in the opposite direction. Its sole job is to prevent drinking water from being contaminated due to backflow.

### Back siphonage

The flowing back of used contaminated or polluted water from a plumbing fixture or vessel into a water supply pipe due to a reduced pressure in such a pipe.

### Bathroom vanity

It can be defined as the combination of the bathroom sink or basin and the storage that surrounds it.

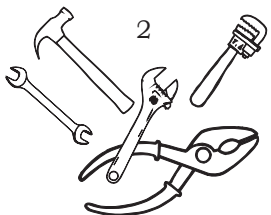

## Bidet

It is a special plumbing fixture that allows a person to use water to wash their genitals, anus, and inner buttocks after using the bathroom. These fixtures are very popular with both men and women in developed countries.

## Branch

Any part of the piping system other than a main pipe is known as branch

### Branch soil pipe (BSP)

A pipe connecting one or more soil appliances to the main soil pipe

### Branch soil waste pipe (BSWP)

A pipe connecting one or more soil and/or waste appliances to the main soil waste pipe (one-pipe system)

### Branch ventilating pipe (BVP)

A pipe, one end of which is connected to the system adjacent to the trap of an appliance and the other to a main ventilating pipe or a drain-ventilating pipe. It is fitted to prevent loss of water seal from a trap, owing to partial vacuum back pressure, or surging caused by air movement within the pipe system. It also provides ventilation for the branch waste pipe.

### Branch waste pipe (BWP)

A pipe connecting one or more waste appliances to the main waste pipe

## Building drain

The building (house) drain is the part of the lowest horizontal piping of a drainage system which receives the discharge from soil, waste, and other drainage pipes inside the walls of the building. It carries the discharge to the building (house) sewer beginning one metre outside the building wall.

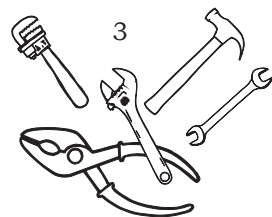

## NOTES

### Building sewer

The building (house) sewer is the part of the horizontal piping of a drainage system which extends from the end of the building drain and which receives the discharge of the building drain and carries it to a public sewer, private sewer, individual sewage-disposal system, or other point of disposal.

### Burr

It is a raised edge or a small piece of material remaining attached to a workpiece after a modification process. It is usually an unwanted piece of material and is removed with a de-burring tool in a process called deburring.

## C

### Cistern

A tank for storing water, especially one supplying taps or as part of a flushing toilet

### Cleaning eye

When removable plug is fitted with removable cover into the pipe fitting as eye opening and clearing of obstructions is done through this opening, it is called access eye or cleaning eye.

### Couplers

When we connect two pieces of uniform or varying diameter pipe, a piece of pipe known as coupler is used for joining these pipes. One end of a coupler may be of a higher or lower diameter size as per requirement.

### Crown of trap

The top-most point of the inside of a trap outlet.

## D

### Diameter

Unless specifically stated, the nominal diameter of pipe fittings

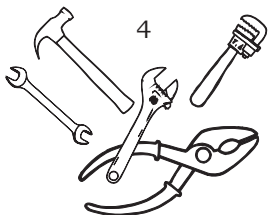

## Direct tap

A tap or faucet, which is connected to a supply pipe and subject to pressure from the water main

## Domestic purposes

All purposes incidental to the occupation of a dwelling

## Downtake tap or faucet

A tap or faucet connected to a system of piping, not subject to water pressure from the water main

## Drain water outlet

Any pipe which conveys discharges from sanitary appliances in a drainage system.

## Drain ventilating pipe (DVP)

It is a pipe installed to provide flow of air to or from a drain to prevent undue concentration of foul air in the drain. The main soil pipe or main waste pipe may serve as drain ventilating pipe wherever its upper portions, which do not receive discharges, are extended to the roof level and let open to the air.

## Dwelling

It is a building—used, constructed or adapted for use, wholly or principally for human habitation. It may include garages, other outhouses, etc.

## E

### Escutcheon

A flat piece of metal for protection and often ornamentation, around a keyhole, door handle, or light switch

## F

### Fitting

It refers to the fixtures in the plumbing system to join straight pipes or any section of tubes. Examples include elbow, tee, socket, reducer, etc.

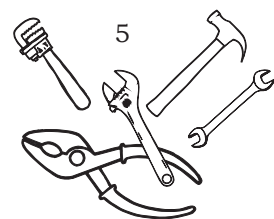

## NOTES

### Fixture unit

A quantity, in terms of which the load producing effects on the plumbing system of different kind of plumbing fixtures are expressed on some randomly chosen scale

### Flange

It is a plate or ring to form a rim at the end of a pipe when fastened to the pipe. A flange joint is a connection of pipes, where the connecting pieces have flanges by which the parts are bolted together.

### Float operated valve

Ball valves or ball taps and equilibrium by valves operated by means of a float

### Floor area of a building

The area of a horizontal section taken at the plinth or floor level of any storey of a building, inclusive of all projecting and overhanging parts of the external walls, and of such portions of the partition walls as belonging to the building

### Flushing cistern

It is a cistern with a device for rapidly discharging the contained water. It is used in connection with a sanitary appliance for the purpose of cleansing the appliance and carrying away its contaminated contents into a drain.

### Fracture

Due to heavy pressure or clogging, there is broken or cracked portion in plumbing pipes, fixture or fittings, due to which leakage takes place.

## G

### Gasket

Mechanical seals, generally ring-shaped and fitted for sealing flange joints

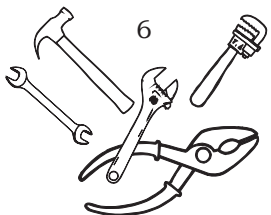



## General washing place

A washing place provided with necessary sanitary arrangement and common to more than one tenement, that is a multi-occupancy building of any sort

## H

### Horizontal pipe

Any pipe or fitting which makes an angle of more than 45° with the vertical

## I

### Induced siphonage

The extraction of water from a trap by a siphonage set up by the reduction of pressure at the outlet of the trap

### Insanitary

Contrary to sanitary principles or injurious to health

## M

### Main soil pipe (MSP)

A pipe connecting one or more branch waste pipes to the drain

### Main soil waste pipe (MSWP)

A pipe connecting one more branch soil waste pipes to the drain

### Main ventilating pipe (MVP)

A pipe which receives a number of branch ventilating pipes

### Main waste pipe (MWP)

A pipe connecting one or more branch waste pipes to the drain

## N

### Nipple

It is a piece of pipe having thread at both sides, and could be used for short extension of plumbing lines.

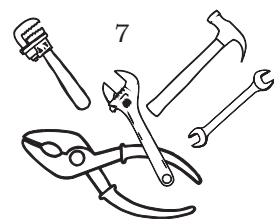

## NOTES

It can also be used for connecting two fittings within a short distance.

### O

#### O-ring

An O-shaped ring that is attached to the faucet to prevent water from oozing out of the spout

### P

#### Period of supply

The period of the day or night during which water supply is made available to the consumer

#### Pipe ears

Two wings cast integrally with the pipe socket provided with holes to take fixing nails or screws

#### Pipe systems

It is an assembly of various components put together with a method of joints, to transport water from the source to destination. The system to be adopted will depend on the type and planning of the building in which it is to be installed and will be one of the following.

1. *One-pipe system*— The plumbing system in which the waste connection from washbasins, baths, and the soil pipe branches are all collected into one main pipe which is connected directly to the drainage system. Gully traps and waste pipes are completely dispensed with but all the traps of water closets, basin, etc., are completely ventilated to preserve water seal.

2. *Two-pipe system*— It is a discharge pipe system comprising two independent discharge pipes, one of which conveys soil directly to the drain, the other conveying waste water to the drain through a trapped gully. The system may also require ventilating pipes.

3. *Single stack system*— One-pipe system without trap ventilation pipework

#### Pipework

Any installation of piping with its fitting

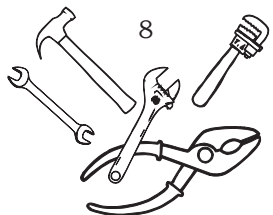

## Plinth

The portion of a structure between the surface of the surrounding ground and surface of the floor, immediately above the ground

## Plumbing

It is the pipes, fixtures and other apparatus inside a building for bringing in the water supply and removing the liquid and water-borne wastes;

It is the installation of the foregoing pipes, fixtures and other apparatus.

## Plumbing system

It shall include the water supply and distribution pipes; plumbing fittings and traps; soil, waste, vent pipes and anti-siphonage pipes; building drains and building sewers including their respective connections, devices and appurtenances within the property lines of the premises and water-treating or water-using equipment.

## Plunger

A tool for cleaning normal blockage in drain and pipe, washbasin, etc.

## Potable water

Water which is satisfactory for drinking, cooking and domestic purposes and meets the requirements of the Bureau of Indian Standards (BIS)

## Premises

It shall include passages, buildings and lands of any tenure, whether open or enclosed, whether built on or not, and whether public or private in respect of which, a water rate or charge is payable to a designated authority or for which an application is made for supply of water

## Public building

A building used or intended to be used either ordinarily or occasionally as a church, temple, mosque or any

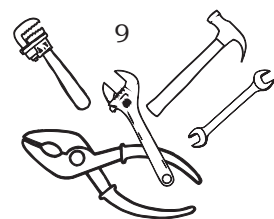

## NOTES

place of public worship, *dharamshala*, college, school, theatre, cinema, public concert room, public hall, public bath, hospital, hotel, restaurant, lecture room or any other place of public assembly

### S

#### Sealing rings

It is a type of gasket used in connecting any fixture or joints to create leak proof condition.

#### Self-siphonage

The extraction of water from a trap by siphonage, setup by the momentum of the discharge from the sanitary appliance to which the trap is attached

#### Service pipe

The pipe that runs between the distribution main in the street and the riser in case of a multi-storeyed building, or the water in case of an individual house, and is subjected to water pressure from such a main

#### Soil pipe (SP)

The pipe used to carry waste from the toilet and waste water

#### Spindle

It is a metal unit that provides the link between the handle and the stem washer.

#### Stack

The main vertical discharge or ventilating pipe

#### Stopcock

A cock fitting in a pipeline for controlling the flow of water

#### Stop tap or faucet

It includes stop cock, stop valve or any other devices for stopping the flow of water in a line or system of pipe at will.

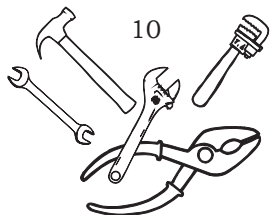

## Storage cistern

A cistern for storing water

## Stuffing box

It is an assembly which is used to house a gland seal. It is used to prevent leakage of fluid, such as water or steam, between sliding or turning parts of machine elements.

## Sullage

The waste water generated from bath and kitchen (but not the waste water from toilets known as excreta)

## Supply pipe

The pipes which lead from the distribution main of water supply to the plumbing system of the house

## Supports

Devices for supporting and securing the pipe and fittings to the walls, ceilings, floors or any extra constructed unit

## T

### Trap

A fitting or device in a P-, U-, S- or J-shaped type. Traps are fitted near a plumbing fixture. The trap bend is fitted to prevent sewer gases from entering the building. It is so designed and constructed as to provide, when properly vented, a liquid seal which will prevent the back passage of air without materially affecting the flow of sewage or water through. If the gases are inserted back into home, then it could lead to people inhaling foul smell, which could cause illnesses. It could even explode.

## V

### Vertical pipe

Any pipe which is installed in a vertical position or which makes an angle of not more than  $45^\circ$  with the vertical

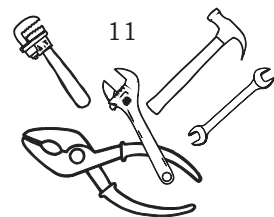

## NOTES

### W

#### Warning pipe

An overflow pipe so fixed that its outlet, whether inside or outside a building, is in a visible position where the discharge of any water from it can be readily seen

#### Washout valve

A device located at the bottom of the tank for the purpose of draining a tank for cleaning, maintenance, etc.

#### Water line

A line marked inside a cistern to indicate the highest water level at which the supply valve should be adjusted to shut off

#### Water main (street main)

It is a pipe laid by the water undertakers for the purpose of giving a general supply of water as distinct from a supply to individual consumers. It includes any apparatus used in connection with such a pipe.

#### Water outlet

As used in connection with the water distributing system, it is the discharge opening for the water (1) to a fitting; (2) to atmospheric pressure (except into an open tank which is part of the water supply); and (3) to any water-operated device or equipment requiring water to operate.

#### Water seal

The water in a trap which acts as a barrier to the passage of air through the trap

#### Water supply system

It consists of the water service pipe, the water-distribution pipes, and the necessary connecting pipes, fittings, control valves, and all fixtures in or adjacent to the building or premises.

#### Water undertaker

The water service provider who owns the supply system and infrastructure and provides water to a defined geographic area

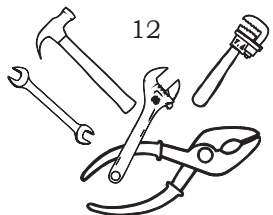

## Waterworks

It refers to an establishment for managing a water supply. Waterworks for public water supply include a lake, river, spring, well, pump with or without motor and accessories, reservoir, cistern, tank, duct whether covered or open, sluice, water main, pipe.

## NOTES

### Practical Exercises

#### Activity 1

Identify whether your home has a one- or two-pipe discharge system.

#### Material required

1. Notebook
2. Pen
3. Paper

#### Procedure

1. Identify the discharge pipe fitted in your home.
2. Check whether one or two pipes are being used as discharge pipe.
3. Prepare a note on this observation.
4. Discuss with your teacher.

#### Activity 2

Visit a school building and identify the various plumbing fittings being used.

#### Material required

1. Notebook
2. Pen
3. Paper

#### Procedure

1. Make a list of various plumbing items and fittings fitted in your school.
2. Identify the various fittings used.
3. Prepare a note on this.

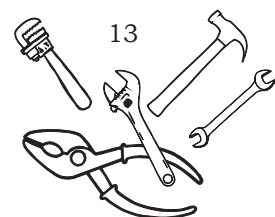

Check Your Progress

**A. Define the following terms**

1. Crown of trap
2. Diameter
3. Drain water outlet
4. Water supply system
5. Flushing cistern

**B. Multiple choice questions**

1. A building used or intended to be used either ordinarily or occasionally as a church, temple or mosque square is
  - (a) premises
  - (b) public building
  - (c) residential building
  - (d) commercial building
2. The main pipe used for vertical discharge, or the ventilating pipe is
  - (a) stack
  - (b) service pipe
  - (c) one pipe system
  - (d) None of these
3. A device for rapidly discharging the contained water and used in connection with a sanitary appliance is
  - (a) float
  - (b) flushing cistern
  - (c) siphon
  - (d) trap
4. The distance between the lowest point of a water inlet or feed pipe to an appliance and the spill-over level is
  - (a) air gap
  - (b) head
  - (c) back flow
  - (d) None of these

**C. Fill in the full forms of the given abbreviations**

1. MSP \_\_\_\_\_
2. MVP \_\_\_\_\_
3. MWP \_\_\_\_\_
4. MSWP \_\_\_\_\_

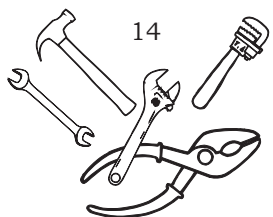



# Unit



## Tools for Plumbing



171121GH02

### INTRODUCTION

So far, we have studied the importance of the plumbing system, and the basic terms related to it. We will now look at the various tools that help a plumber perform the plumbing activities effectively. Like any other sector, a thorough knowledge and working of tools and equipment used in plumbing are essential for a plumber to carry out the tasks.

A plumber requires several tools for the fitting work for plumbing, fixing a tap or to carry out repairs. These tools help the plumber in performing one's work properly, and therefore it is important that the tools are used systematically and handled carefully to avoid any damage. They should be kept at a designated place after use. The tools can be categorised as per the nature of work like holding tools, fitting tools, cutting tools, pipe threading and bending tools, etc.

The major tools used in plumbing are categorised as follows.

#### **1. Holding tools**

- (a) Bench vice
- (b) Pipe vice

#### **2. Fitting tools**

- (a) Wrenches
- (b) Water-pump pliers
- (c) Spanners

## NOTES

### 3. Cutting tools

- (a) Pipe cutter
- (b) Hacksaw

### 4. Pipe bending tools

- (a) Pipe bending machine
- (b) Threading dies

### 5. Other tools

- (a) Chisel
- (b) Hammer
- (c) Chain wrench
- (d) Rover jumper
- (e) Trowel
- (f) Screwdriver
- (g) File
- (h) Plier
- (i) Caulking tools
- (j) Drill machine
- (k) Drill bit
- (l) Hanger
- (m) Measuring tape
- (n) Plumb rule and bob
- (o) Spirit level
- (p) Spade
- (q) Shovel
- (r) Pickaxe
- (s) Mortar pan
- (t) Mason's square
- (u) Water level tube

## HOLDING TOOLS

Tools which are used for holding the pipes, pipe fittings and fixtures for plumbing operations are called holding tools. Some of the commonly used holding tools are mentioned below.

### Bench vice

A vice is a tool used for holding an object for various tasks like filing, chipping, sawing, threading, tapping, bending, etc. The bench vice has two jaws, one of which is fixed and the other is movable. These jaws are fitted with plates for a better grip on the object during the

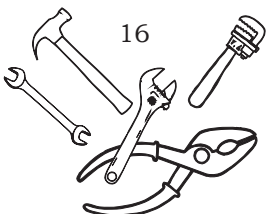

task. The vice size depends on the width of the jaw. A bench vice is fixed to a table or a bench through a bolt. A vice is opened and closed with the help of a handle attached to a spindle. In this way, the object is held tightly. Bench vices hold the objects and allow the use of other tools to complete the tasks (Fig. 2.1).

### Pipe vice

It is a tool used for holding a pipe for carrying out assembly, disassembly, threading, cutting, etc. (Fig. 2.2). Pipe vices are of two types.

1. Open side pipe vice
2. Fixed side pipe vice

Standard sizes of vices are 80 mm, 105 mm, 130 mm, 170 mm, etc., as per the opened size of the jaws.

### FITTING TOOLS

While holding tools are used to keep the objects in place, fitting tools are used for carrying out various plumbing operations like cutting, tightening, fixing and other small tasks.

### Wrenches

These are hand tools used for tightening and loosening the nuts and bolts (Fig. 2.3). Wrenches hold slippery or small nuts and bolts for loosening or tightening them. Mostly, two types of wrenches are used—adjustable and non-adjustable. These are useful particularly in case of odd-sized nuts and bolts. These tools hold a pipe and pipe fittings for screwing or unscrewing. This is a very common tool, especially for small diameter pipes upto 50 mm.

#### Adjustable wrench

This type of wrench is used to loosen or tighten the nuts and bolts of any odd and regular sizes. It is used for tightening and loosening valves, cocks, geysers, flexible pipes, etc. It is a good maintenance tool for repair of plumbing items like valves, cocks, pumps, etc.



Fig. 2.1: Bench vice



Fig. 2.2: Pipe vice

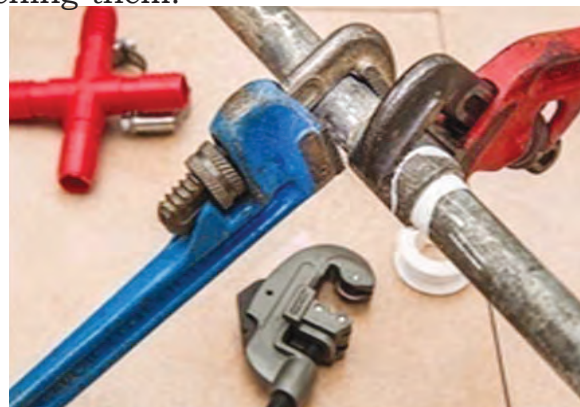

Fig. 2.3: Pipe wrenches



Fig. 2.4: Different types of wrench (adjustable)



Fig. 2.5: Adjustable wrench



Fig. 2.6: Water-pump pliers

It has a fixed flat jaw with a handle and a square-toothed screw (Fig. 2.5). The movable flat jaw slides in the body of the fixed jaw with the support of a screw. The gap between the flat jaws is used to hold the object to be twisted for screwing or unscrewing.

### Water-pump plier

It is a common plier used by plumbers for holding, tightening and loosening work during the fixing process.

Steel is used for manufacturing water-pump pliers. These are available in only one standard size of 250 mm length. The maximum width possible between the two jaws is 40 mm (Fig. 2.6).

### Spanners

This tool is used for tightening and loosening nuts and bolts of standard size. The standard spanners used are discussed below.

#### Ring spanners



Fig. 2.7 (a) Ring spanner

These spanners have full circular closed ring at both ends. It is difficult to slip and cause damage. It is made through forging process, with a burnished finish or chrome-plating (Fig. 2.7a).

#### Open-ended spanners



Fig. 2.7 (b) Open-ended spanner

These types of spanners are open from both sides and are used for tightening and loosening nuts and bolts (Fig. 2.7b).

A spanner having open-ended jaws slides through the nut or bolt with square or hexagonal heads. The bolts or nuts are then turned with the required force to screw or to unscrew. The two jaws have two consecutive sizes like 6 mm and 7 mm or 1/4" and 5/16", etc.

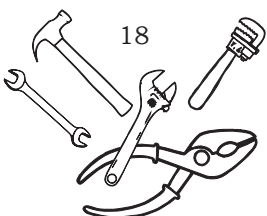

## Combination spanners

These spanners are open at one end and closed at the other (Fig. 2.7c).

## Bi-hexagonal ring spanner

It has a bi-hexagonal shape at both the ends to hold a nut or bolt, the head of which is square or hexagonal. The sizes of the two ends are consecutive like 6 mm and 7 mm, 1/4" and 5/16", etc. (Fig. 2.8).

## CUTTING TOOLS

Tools that are used for cutting the pipes, fixtures and bolts, etc., are known as cutting tools. Some of the commonly used cutting tools are mentioned below.

### Pipe cutter

This is a manual tool used to cut a pipe at the work site, especially when it is difficult to use a hacksaw frame. This tool has a sharp, round cutting wheel which is pressed with to and fro rotary motion for cutting a pipe (Fig. 2.9).

### Hacksaw

This tool is generally used with both the hands. It cuts material like plastic pipe, steel rod, angle iron, sheets, iron pipes, etc. It can also be used for cutting the bolt heads and nuts when they are jammed. Important parts of a hacksaw are—handle, frame, blade and adjusting wing nut (Fig. 2.10).

A hand-operated hacksaw is used for site work while a power hacksaw is used in a workshop for cutting heavy pipes quickly (Fig. 2.11).

## PIPE BENDING TOOLS

In most of the plumbing operations, pipes are required to be bent at different angles as per requirement, for which pipe bending tools are used. Some of these tools are mentioned below.

### Pipe bending machine

This equipment is used to bend or turn pipes. The size and strength of the machine depends upon the diameter



Fig. 2.7 (c) Combination spanner



Fig. 2.8: Bi-hexagonal spanner



Fig. 2.9: Pipe cutter



Fig. 2.10: Hand-operated hacksaw



Fig. 2.11: Power hacksaw



Fig. 2.12: Pipe bending machine

of the pipe and the type of the pipe material to be bent. The mechanical or hand-operated pipe bending machines are available for 3/8– 1" diameter pipes. For higher ranges, i.e., 1/2–2", 1/2 – 3", 1/2– 4" and 2– 6", hydraulic hand-operated machines are used (Fig. 2.12).



Fig. 2.13: Threading die

### Threading dies

Threading is crucial for joining pipes and fixtures effectively. A threading die is used for making threads in a pipe where it is to be joined with another pipe or fixture (Fig. 2.13).

### OTHER TOOLS

Apart from the already mentioned holding, fitting, cutting and bending tools, various other tools are also used in plumbing operations. These are listed below.



Fig. 2.14: Chisel

### Chisel

It is made of hard metal and is mostly used for cutting concrete surface and making grooves in the walls with the help of a hammer (Fig. 2.14).



Fig. 2.15: Hammers

### Hammer

These are general purpose workshop hand tools used for straightening of sections, riveting, striking of nails and inserting the component by striking, inserting keyways and fitting by striking. The hammer consists of a head made of hard and tempered steel, and a wooden handle. The head has a flat striking face and the other side is called pein. The peins are classified as per different shapes such as ball pein, cross pein and straight pein. The hammers made of hardened steel are known as engineer's hammers and are usually used while working with steel components. A one-kilogram hammer is the most commonly used hammer (Fig. 2.15).

### Chain wrench

The common holding tools do not help much in case of large diameter pipes. For these, chain wrenches are used. A chain wrench consists of a toothed block, a

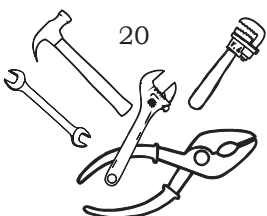

handle and a chain. The chain is round, grooved and held on the toothed end of the block. The chain grips the pipe fitting and screws or unscrews. The chain wrench is available in 3", 4", 6", 8" and 12", with the length 475 mm, 585 mm, 834 mm, 1100 mm and 1360 mm respectively. These sizes are designated by the maximum diameter of the pipe it can hold (Fig. 2.16).



Fig. 2.16: Chain wrench

### Screwdriver

This tool is often used by plumbers to fit the screws. Screwdrivers have a sharp tip which can easily fit into various screws. Different types of screwdriver are used for various types of screw. Various types of heads of the screwdriver are used by plumbers (Fig. 2.17).



Fig. 2.17: Screwdriver

### Files

These hand tools are used for a variety of work, like removing of sharp edges, metal removal, shaping of jobs, smoothening of surfaces, finishing, producing different shapes, etc. The file has five parts—tang, heel, face, edge and point or tip. Various types of files of different shapes like hand round, pillar, square, three square, half round, flat, knife edge and needle file are used as per the work (Fig. 2.18).



Fig. 2.18: File

### Pliers

They are important tools used for holding small objects and for tightening or loosening various parts. Several types of pliers are used during plumbing work. Pliers can be used for cutting purpose also. Various shapes and sizes of pliers are available in the market.



Fig. 2.19: Plier

### Caulking tools

Caulk or caulking is a material used to seal joints or seams against leakage in various structures and piping. Caulking tools help in filling and removing material in the building (Fig. 2.20).



Fig. 2.20: Caulking tools

### Drill machine

One of the common but important tools used for making a hole in a metal or wood, or concrete surface is a drill machine (Fig. 2.21). It is fitted with a cutting tool like

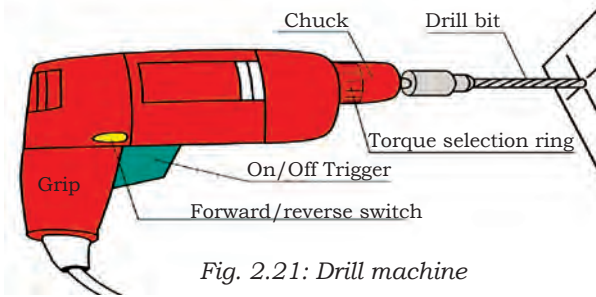

Fig. 2.21: Drill machine

a drill bit. The attachment is tightened with a key.

### Safety precautions

Before installing the bit in a drill machine, it should be sharpened. The key in the chuck, a part of the drill machine used for tightening the drill bit, should be removed after tightening.



Fig. 2.22: Drill bits

### Drill bits

These are the tools used to make cylindrical holes by cutting the material. It is fitted in a tool which rotates it and make the hole. For non-cylindrical shaped holes, specialised bits are used (Fig. 2.22).



Fig. 2.23: Pipe hangers

### Hangers

The purpose of a pipe hanger is to hold or support a pipe or a group of pipes from a slab, beam, ceiling or other structural elements (Fig. 2.23).

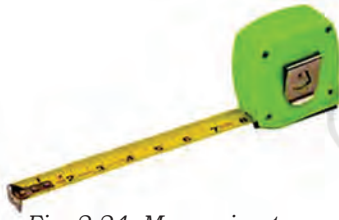

Fig. 2.24: Measuring tape

### Measuring tape

It is used for measuring the length, breadth and height of an item. The measuring tape is manufactured in various material like steel, cloth and PVC. The length range available is one metre, two metres, three metres, five metres, 10 metres, 15 metres, etc. (Fig. 2.24).



Fig. 2.25: Plumb bob

### Plumb rule and bob

This is a useful tool to ensure verticality and uniformity during construction of walls, columns and wooden frames like doors and windows. It also helps in levelling the surface of the floor. It consists of a holding pipe, thread and a plumb bob made of wood and metal. The plumb bob is connected to the holding pipe with the thread (Fig. 2.25).



Fig. 2.26: Spirit level

### Spirit level

It is used to check the horizontality or levelling of the floor, roof, door, window frame, etc. (Fig. 2.26).

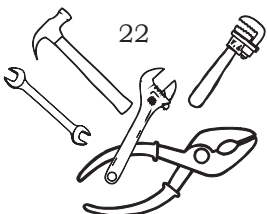



## Trowel

It is used for mixing cement and sand for masonry work. It is used for plastering the surface (Fig. 2.27).



Fig. 2.27: Trowel

## Spade

It is used for digging purpose and for mixing cement, sand and concrete. It consists of a flat form made of steel with an eye hole to hold the wooden handle. The size of a spade is designated by its width and length of the plank (Fig. 2.28).



Fig. 2.28: Spade

## Shovel

It is used for mixing concrete and also for carrying concrete to mortar pans. Shovels are made of steel sheets. The size is designated by its length and width (Fig. 2.29).



Fig. 2.29: Shovel

## Pickaxe

It is made of steel and is used to excavate hard soil. One end of the pickaxe is flat whereas, the other end is sharp in design (Fig. 2.30).



Fig. 2.30: Pickaxe

## Mortar pan

This is used to carry the excavated material, cement mortar, concrete, etc. It should never be used for measurement of mixed cement mortar, etc. Mild steel sheet is used for making mortar pan (Fig. 2.31).



Fig. 2.31: Mortar pan

## Mason's square

It is used to check rectangularity of external and internal corners. It is made of carbon steel sheet. The dimension is also marked on both the sides, either in inch or centimetre (Fig. 2.32).



Fig. 2.32: Mason's square

## Water level tube

This tube is used to check and transfer water levels, etc. Water is poured inside the tube at the time of use. Polythene tubes of varying diameter from 10 to 15 mm, and lengths varying as per the requirement are used (Fig. 2.33).



Fig. 2.33: Water level tube

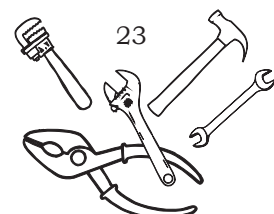



Fig. 2.34: Rover jumper

## Rover jumper

It is used for making a gap in the wall so that plumbing fixtures can be fixed (Fig. 2.34).

## SAFETY DURING WORK

The following precautionary measures may be taken for the safe use of plumbing tools.

1. Use the correct methods given in the 'Instruction Manual of tools' while using them.
2. Use the appropriate tools required for the specific work or job. For example, do not use pliers instead of a hammer; use only a hacksaw to cut.
3. Keep the tools in working condition and ensure the required maintenance.
4. Ensure that the necessary protective equipment are available.
5. Follow safety methods while using electrical wires. For instance, make sure your hands are absolutely dry while coming in contact with electrical wires.
6. Use kerosene oil for removing dust from rusty nuts.
7. Do not use tools without a handle as they may not give proper grip.
8. Remove burrs or stuck material from the head of the chisel and the edges of tools.
9. Wear safety glasses while using power tools like a drill machine.
10. Keep metal parts lightly lubricated.
11. Do not apply excessive pressure or force.
12. Inspect the tools regularly.
13. Use or wear safety gear (helmet, gloves, goggles, safety shoes, ear plugs, etc.).

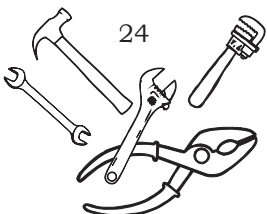

## Practical Exercises

## NOTES

### Activity 1

Draw figures of plumbing tools.

#### Material required

1. Pen
2. Pencil
3. Plumbing tools

#### Procedure

1. Collect the plumbing tools available in your classroom.
2. Draw figures of the plumbing tools and label them.

### Activity 2

Draw figures of masonry tools.

#### Material required

1. Pen
2. Pencil
3. Masonry tools

#### Procedure

1. Collect the masonry tools available in your classroom.
2. Draw figures of the masonry tools and label them.

## Check Your Progress

### A. Answer the following questions

1. Classify the different plumbing tools according to their use.
2. Give the uses of the following
  - (a) Holding tools
  - (b) Fitting tools
  - (c) Cutting tools and
  - (d) Pipe bending tools
3. Discuss the role of chain wrench in plumbing work.
4. Why is a wrench used in the plumbing work? What is the purpose of using an adjustable wrench?
5. Discuss the role of the plumb rule and bob. Also mention its different parts.

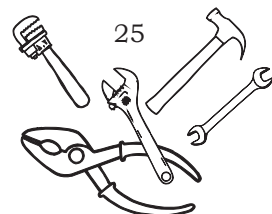

## NOTES





### B. Fill in the blanks

1. The \_\_\_\_\_ is a work holding device.
2. The purpose of a pipe hanger is to \_\_\_\_\_ or \_\_\_\_\_ a pipe or a group of pipes.
3. \_\_\_\_\_ is used to check rectangularity of external and internal corners.
4. \_\_\_\_\_ is a tool used for making a hole in a metal or wood.

### C. Multiple choice questions

1. Which of the following instruments indicate whether a surface is horizontal or vertical?
  - (a) Square
  - (b) Spirit level
  - (c) Plumb
  - (d) Crowbar
2. The device which is used to hold a pipe for carrying out assembly, disassembly, threading and cutting is
  - (a) wrench
  - (b) pipe vice
  - (c) bench pipe
  - (d) hack saw
3. A threading die is used to
  - (a) cut pipe
  - (b) cut grooves of threads
  - (c) unscrew water pipes
  - (d) seal joints
4. Measuring tape is used to measure
  - (a) length
  - (b) breadth
  - (c) height
  - (d) All of the above

### D. Match the following

1. Tool used for mixing concrete	(a)	
2. Tool used in plumbing for cutting and jointing works	(b)	
3. Tool to cut a pipe at site	(c)	
4. Vice used to hold the assembly	(d)	

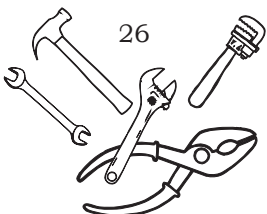

Unit



## Use of Power Tools



171121GH03

### INTRODUCTION

When we use hand tools, a lot of labour and time is consumed in an activity. So, a need was felt to ease the plumbing task at hand. Thus, power tools were introduced. These tools are operated by an additional power source, using electric motors, engines and compressed air, etc.

These power tools are used for various types of domestic as well as industrial work. Power tools are commonly used in the garden, in construction, in industries for drilling, shaping, cutting, sanding, grinding, routing, heating, polishing and painting, etc., Power tools may also be used for domestic tasks such as cleaning, cooking, etc., or for the loosening and tightening of fasteners, etc.

There are mainly two types of power tools used—portable and stationary. Portable power tools are movable and can be easily taken by the technician for use. For more speed and accuracy of work, stationary power tools are preferred. These cannot be moved from one place to another.

Machine tools are also known as stationary power tools. Drill presses and bench grinders used for woodwork and metal work are examples of stationary power tools.

Portable power tools produce large amounts of noise and vibration. Thus, it is necessary that the technician must use a hearing protection kit to guard oneself against the loss of hearing. The common power tools namely drills, circular saws, belt sanders, and chainsaws, operate at sound levels between the 85–100 dB. Various agencies like the NIOSH (National Institute for Occupational Safety and Health) strongly advocate the use of a hearing protection kit while using power tools at work.

### Types of power tool

1. Air compressor
2. Power wrench—impact wrench, air ratchet wrench and pneumatic torque wrench
3. Multi-tool
4. Manual impact driver
5. Jigsaw power tool

### Air compressor

It is a mechanical device which utilises energy to compress air. It converts power using an electric motor, mostly into potential energy stored in pressurised air (that is, compressed air). An air compressor draws more air into a storage tank, so that pressure is increased.

When pressure in the tank reaches its upper limits, the air compressor turns off automatically. The compressed air is stored in the tank till it is used.

Energy, in the form of compressed air is used for various purposes such as cleaning of dirt, opening the pneumatic wrench, etc. When air gets released, the tank's pressure level reaches its lower limit. Thus, the air compressor turns on again, and re-pressurising of the air in the tank starts.

An air compressor (Fig. 3.1) is different from an air pump which merely draws air from one place into another. There is no air tank in air pumps for storing the pressurised air. Air pumps are much slower, quieter,



Fig. 3.1: Air compressor

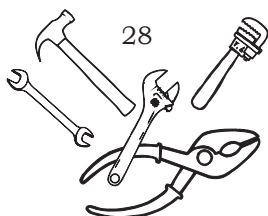

cheaper and easy to operate than an air compressor. A heavy-duty machine uses an air compressor machine to suck dust and waste stocked in the pipeline. You must have seen big suction machines in city municipalities for various operations in sewage cleaning.

## Power wrench

It is a type of wrench that uses a power source. A typical power source used is compressed air. The types of power wrenches include—impact wrenches, air ratchet wrenches and pneumatic wrenches.

### **Impact wrench**

It is a socket wrench power tool designed to deliver high torque (a force that tends to cause rotation) output with minimal exertion by the user. It is also known as an impactor, impact gun, air wrench, air gun, rattle gun, torque gun or windy gun. Impact wrenches are mostly used in many industries, such as automotive repair, heavy equipment maintenance, product assembly, major construction projects and any other instance where a high torque output is needed (Fig. 3.2).

Impact wrenches are available in various sizes from small ¼" drive tools for small assembly and disassembly, upto 3½" and larger square drives for major construction. It is used when high levels of torque is needed. For industrial plumbing work, impact wrenches are used. It helps the plumber for smooth operation of tools and machinery.

### **Air ratchet wrench**

These are useful for loosening or tightening of low-to-medium torque bolts. An air ratchet wrench (Fig. 3.3) is very similar to a hand-operated power ratchet wrench in which an air motor is connected to turn the socket drive. When we pull the trigger, then the motor is activated which turns the socket drive. A switch is fitted to change the direction of the socket drive. This wrench is developed and used more for speed and less for torque. It is used in both domestic as well industrial plumbing work.



Fig. 3.2: Impact wrench



Fig. 3.3: Air ratchet wrench



Fig. 3.4: Pneumatic torque wrench

### **Pneumatic torque wrench**

It is a specially designed tool with a gearbox attached to a pneumatic air motor. It consists of a reaction device which absorbs the torque and lets the tool operator operate it with very little effort. The torque output is controlled by controlling the air pressure. A pneumatic torque wrench produces very little vibration with high accuracy. Such a wrench is controlled by a continuous gearing system (Fig. 3.4). This tool enables the plumber in easy opening and tightening of nuts and bolts.



Fig. 3.5: Multi-tool

### **Multi-tool**

It is used for multiple works like sawing, sanding, rasping, grinding, scraping, cutting and polishing, etc. Offset attachments are fitted in this unit and various types work are performed. This tool can be operated by battery or electricity. It can cut small, and precise to complex cuts (Fig. 3.5).

Multi-tool performs various types of plumbing work during installation and fixing the fixtures.

### **Impact driver**

It is a high torque tool used by mechanics to loosen larger screws (bolts) and nuts which are corrosively frozen or over-torqued. These tools can produce a strong, rotational and downward force in clockwise and anticlockwise direction. This tool can also tighten the screws with greater torque than a screwdriver. This tool is smaller and light in weight than drill drivers. It may be observed that these tools are not as versatile and they perform many of the same functions. Since their torque output is higher than a typical drill driver, it makes it good



Fig. 3.6: Manual impact driver

for carrying out work more quickly. In plumbing works, various rusted or jammed joints, nuts and bolts, can be easily opened with this tool.

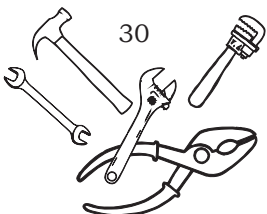



### ***Precautions during handling of power tools***

During handling and operation, the following precautions must be followed to avoid injury to the worker.

1. The work area should be free of any equipment or tool that could cause tripping hazards. Also, avoid working in slippery conditions.
2. Do not stand on uneven surface while working.
3. Do not work directly above other employees or within arm's reach of other employees.
4. Work should be done in proper light. Do not work in the dark or with poor lighting.
5. Always wear non-slippery leather shoes or boots.
6. Read and understand the operator's manual. Ensure that you are completely aware of the use and operation of the power tools. Understand the method of using the tool, its proper application and limitations.
7. Always stay alert.
8. Avoid the work of operating the tool when tired.
9. It is always recommended that new employees must be deployed to work with an experienced senior employee.
10. Protective safety goggles must be used when using power tools and saws.
11. Wear ear protection when using tools for longer duration.
12. Check the tool and ensure it is in good condition; the battery must be firmly in place.
13. Do not open battery of tools during rain.
14. Tools operated with electric wire should be regularly checked. Ensure that the electric wire is not broken or damaged. Extension cords should be grounded.
15. Do not work in watery areas.
16. Tools with bad cords or missing ground plug should be red tagged and not used.

### **NOTES**

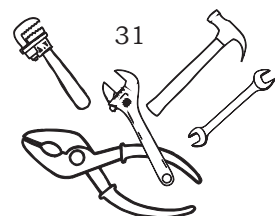

17. Keep the tools packed and unplugged, when not in use.
18. Avoid wearing loose clothing or keeping hair untied.
19. Be aware of electrical wire locations before drilling or sawing in the wall.
20. Do not keep the chuck key attached while drilling or saw before plugging in.

## CLASSIFICATION OF IMPORTANT PLUMBING POWER TOOLS

1. Plumbing drills
2. Plumbing saws
3. Plumbing grinders

We will be discussing the different types of power tools used in plumbing and allied operations, in detail below.



Fig. 3.7: Power drill

### Plumbing drills

A drill is a tool fitted with a cutting tool attachment used to make holes in a surface, wall or pipes as per requirement. During drilling, the drill bits are fitted in the drilling machine.

### Drill bits

These are the cutting tools that help in removing the material to create holes. Long drill bits (cutting tools to remove material to create holes) help in making a hole where pipes or wires have to be laid. Similarly, drill bits are also used for demolition projects. In a drill machine, a drill bit is used for making holes as per requirement. Common sizes of drill bits are 18 and 24 inches long. While the 18-inch drill bit is used for working off the ground or special places, the 24-inch bit is used for heavy operations.



Fig. 3.8: Drill bit (18 inches)

The attachment of a drill bit is held by a chuck at one end of the drill and the same is rotated while pressing against the selected material. The tip, and sometimes edges of the cutting tool also help cut the material. This helps in cutting down thin shavings, breaking

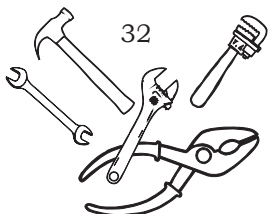

and removing pieces of the work piece, crushing off small particles (oil drilling), counter boring, or similar operations. Drills are mostly used in metalwork, woodwork, construction and do-it-yourself projects. Specially designed drills are also used for specialised places like pharmaceuticals, space missions, etc. Heavy duty works in industrial plumbing are done with the help of a power drill.

The power drill driver is a multipurpose tool. It can be used not only to drill holes in a surface, but also as a screwdriver. With this tool, the user can drill a pilot hole and install a fastener easily. Many types of drill drivers are available in the shops; we can select a type with a keyless shank for doing frequent bit changes, smoothly and fast.

Regular power drivers are easy to use for plastic, wood, wall and softer materials. A power drill can help do the work which cannot be done with the help of a hand drill, thus, increasing productivity. For heavy work, or when working with concrete surface, a heavy duty drill machine is used. Hammer drills help break the concrete, asphalt or hard construction material.

### ***Precautions while using a power drill***

The drill must be held in a safe and comfortable position with both hands to avoid the risk of hurting the wrist of the operator. Check the drill bits regularly and use the exact size of bit for drilling. Small material should be clamped properly. Large material must be held firmly. Follow the correct drill speed. Always wear safety goggles and ear protection to avoid accidents.

### **Plumbing saws**

These are tools and machines used to cut hard material such as pipes or wood. Nowadays, plastic or polyvinyl chloride (PVC) has replaced the traditional pipes like asbestos, metal, etc. A PVC pipe is easy to cut using a handsaw or a power saw. It is because PVC only requires, that like metal, you cut the outside diameter of the pipe. While wood and metal leave behind splinters or metal filaments which can become cumbersome, PVC only leaves behind small traces of plastic particles

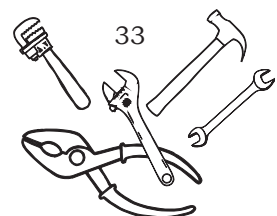

which can easily be cleaned up by hand without injury. A power saw is ideal when large quantities of PVC pipe and heavy duty plastic pipes need to be cut. Power saws are however, expensive. Power saw can use the existing wood blade to cut PVC pipe without buying a special blade. With the help of power saw, cutting can be done fast, which saves a lot of time.



Fig. 3.9: Circular power saw

### Circular saw

It is one of the important power saws which uses a toothed or abrasive disc or blade to cut various materials using a rotary motion. A wheel saw and ring saw also apply a circular motion but it is dissimilar from a circular saw. Sometimes circular saw is also used loosely for the blade itself (Fig. 3.9).

Circular saws can be used for cutting the PVC pipes or metallic pipes in plumbing.



Fig. 3.10: Hacksaw

### Hacksaw

The hacksaw is the most common tool to cut lengths of PVC pipe, as it is commonly available. Hacksaws work well, but are somewhat time consuming and can cause additional work to de-burr the edges of the cut PVC pipe. A hacksaw is the ideal tool to use if we only need to cut one or several pieces of pipe.



Fig. 3.11: Jigsaw power tool

### Jigsaw power tool

It is an electric saw made up of an electric motor and a reciprocating saw blade. A jigsaw can work with wood, metal, drywall or fibreglass. The blades are selected based on the work, material and project type. Blades are graded by teeth per inch (TPI). A low TPI is used for a rougher cut, and it is suitable for cutting wood. Higher TPI blades are selected for small, fine, detailed cuts (Fig. 3.11).

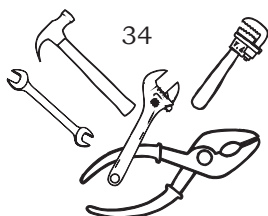

### ***Precautions during handling saw***

1. Place guards on the saw correctly.
2. Keep both hands on the saw's two handles.
3. Wear safety goggles and ear protection before starting the sawing.
4. Position your body to the left or right side of the blade to avoid being kicked back.
5. Going under the material when sawing is on, must be strictly prohibited.
6. Use the recommended blade for cutting the material.
7. Check for a jammed saw; do not use such a saw.
8. Remove the plug or battery while changing blades.
9. Check the blades regularly and keep in working condition.
10. Keep perfect footing for balance.
11. Use clamps and vices for holding the material to be cut, at all times.
12. Adjust the saw for actual depth.
13. Cut slowly and carefully, the green, treated or wet material.
14. Wear a respirator (mask) to avoid dust, when cutting treated wood, concrete, tile, or stone.
15. Cut the treated lumber in an open and well-ventilated area.
16. Do not exert more load against your body while you are working.
17. Never hold wood with your hand while working.
18. Take special care if electric wire is inside the wall. Turn off electricity at the place of work or the building.
19. Take special care while cutting below the intended board.
20. Always follow safety instructions given in the operator's handbook.

### **NOTES**

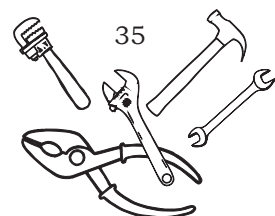

## Plumbing grinder

A grinder consists of an abrasive wheel which works as the cutting tool. The grinder abrasive stone on the wheel's surface cuts a small chip from the work piece via deformation. Grinding is applied for finishing work pieces for high surface quality and better accuracy of shape and dimension. A grinder helps in grinding upto the order of 0.000025 mm. Grinder can do a concluding operation and deletes comparatively small metal, about 0.25 to 0.50 mm depth. In plumbing works, various types of finishing work are done with help of grinder.



Fig. 3.12: Grinder

## Practical Exercises

### Activity 1

Visit a hardware store and make a list of the plumbing power tools available.

#### Material required

1. Pen
2. Paper and
3. File

#### Procedure

1. Identify the hardware store in your area and visit it.
2. Based on your reading of this Unit, collect the information of the different plumbing power tools available.
3. Collect a pamphlet or leaflet of the tools, if available. Else click pictures of the tools you can find.
4. Attach these in your file after identifying each of these.

### Activity 2

Visit to a construction site of a commercial building or manufacturing industry

#### Material required

1. Pen
2. Paper and
3. File

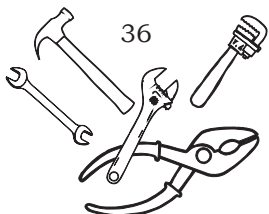

**Procedure**

1. Visit a construction site of a commercial building or manufacturing industry with your teacher.
2. Observe and identify the power tools being used at the site.
3. Discuss with the technician regarding the handling of power tools.
4. Discuss the safety features of the power tools.
5. Based on this visit and your conversation with the technician, make a report of the same.

**Activity 3**

Assembling and disassembling the parts of a compressor

**Material required**

1. Compressor
2. Tool kit
3. Cotton duster
4. Mat or bedsheet

**Procedure**

1. Take the compressor available in school.
2. Switch off the plug and remove the cable.
3. Read the operator's manual for instructions on disassembling.
4. With the help of tools, disassemble the components.
5. Identify each of the parts.
6. With the help of tools, assemble the components.
7. Operate the compressor and check any noise, etc.
8. Clean the tools and keep in a tool box.

**Check Your Progress****A. Answer the following questions**

1. Why do we use power tools?
2. Discuss three important power tools used in plumbing.
3. Differentiate between hand tools and power tool.
4. Why do we use a multi-tool?
5. Why is it necessary to take precautions during the handling of power tools?

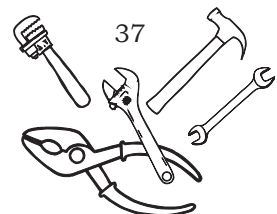

## NOTES

### B. Fill in the blanks

1. Power tools are classified as either \_\_\_\_\_ or portable.
2. Hand held power tools produce a large amount of \_\_\_\_\_.
3. Power plumbing drill is also used for \_\_\_\_\_.
4. \_\_\_\_\_ should be placed on the saw while operating.
5. Air compressor converts power into \_\_\_\_\_ energy.

### C. Multiple choice questions

1. An impact wrench is also known as
  - (a) impact gun
  - (b) air wrench
  - (c) air gun
  - (d) All of these
2. Power tools are mostly used for
  - (a) heavy work
  - (b) light work
  - (c) simple work
  - (d) None of these
3. A jigsaw with a bevel function on the sole plate allows cutting angles of upto
  - (a) 45 degrees
  - (b) 60 degrees
  - (c) 30 degrees
  - (d) 35 degrees
4. An air compressor is a device that converts power into
  - (a) kinetic energy
  - (b) rotational energy
  - (c) potential energy
  - (d) None of these
5. Drills are commonly used in
  - (a) woodwork
  - (b) metal work
  - (c) construction
  - (d) All of these

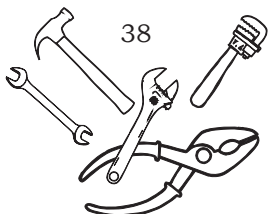



Unit



# Installation of Basic Sanitary Fittings and Fixtures

## INTRODUCTION

You must have seen plumbing and sanitary fittings and fixtures installed in the kitchen, bathroom or toilets of your home, school or other buildings. Many people confuse the words plumbing fittings and plumbing fixtures. A plumbing fixture is a part that is connected to a plumbing system and carries water through a building. The most common plumbing fixtures are bathtubs, sinks, showers, tubs, toilets and faucets. While a fixture can be fixed into walls or the floor, a fitting is an item that can be hung by a hook, screw or nail.

## Plumbing fittings

Various types of pipe fitting are available in plumbing systems for different purposes and functions. A pipe fitting is used in the plumbing system to join multiple pipes of same size or different sizes, to regulate the flow or to measure the flow. They are made, up of different materials like copper, iron, brass, PVC, etc.

There are many different kinds of fittings, made from a variety of materials. Some of the most common types are as follows.



171121CH04

## Types of fittings

1. Collar
2. Elbow
3. Gasket
4. Union
5. Reducer
6. Tee
7. Nipple
8. Trap

For a building, the plumbing system should be designed in a way that water is distributed uniformly, throughout the day. It should be ensured that a combination of fittings and fixtures is selected in such a way that uniform supply of water and discharge of water is maintained.



Fig. 4.1: Collars

### Collar

While joining two pipes in the same length, collar is used. It is fitted at the end of the pipe (Fig. 4.1).

### Elbow

It is installed at the time of joining two pipes. With the help of an elbow, the direction of liquid is changed. Normally a 45 degree or 90 degree elbow is used. When the two sides of pipes differ in size, an elbow of reducing size is used. This is called reducing type elbow or reducer type elbow.

Elbows are categorised as follows.

#### **Long Radius (LR) elbows**

Here, the radius is 1.5 times the diameter of pipe.

#### **Short Radius (SR) elbows**

In this, the radius is 1.0 times the diameter of pipe.

#### **45-degree elbow**

This is used when the change in direction required is 45 degrees (Fig. 4.2).

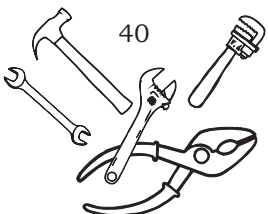

### 90-degree elbow

This is used when the change in direction required is 90 degrees (Fig. 4.3).

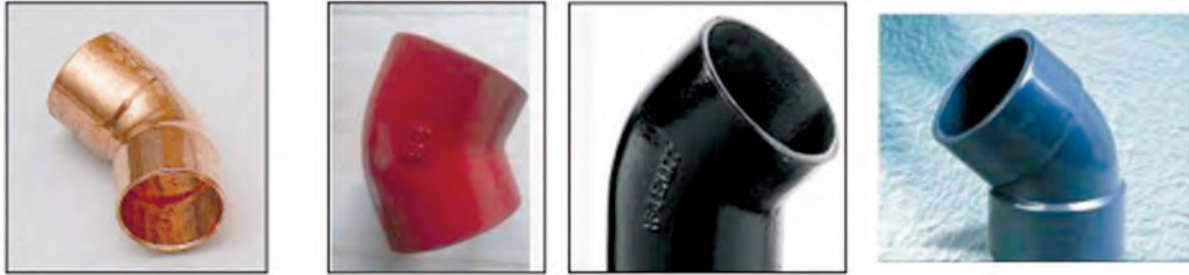

Fig. 4.2: Bend 45 degree

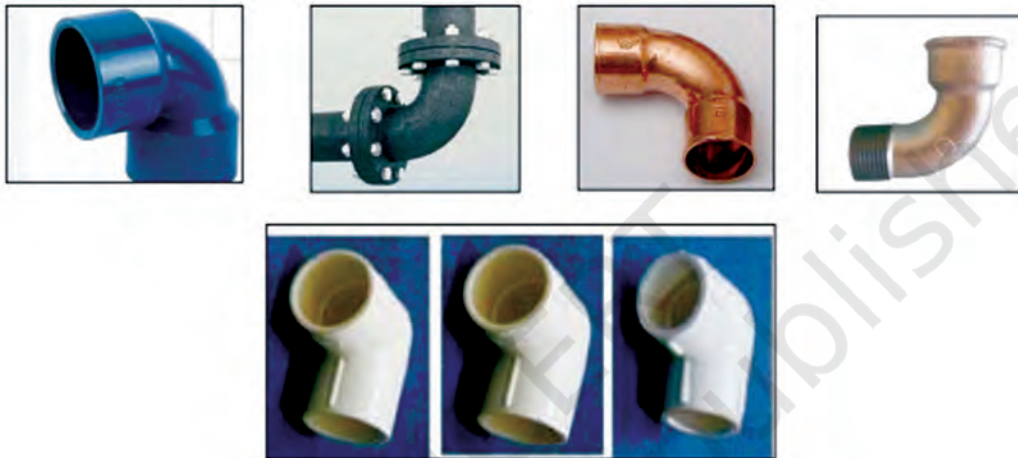

Fig. 4.3: Bend 90 degree



Fig. 4.4: Y-T joint



Fig. 4.5: Double Y-T joint-1



Fig. 4.6: Double Y-T joint-2



Fig. 4.7: T-trap



Fig. 4.8: Gasket



Fig. 4.9: Union

### Gasket

They are mechanical seals, generally ring-shaped and fitted for sealing flange joints. A flange joint is a plate or ring to form a rim at the end of a pipe when fastened to the pipe. Gaskets are made as per by construction, materials and features. Important gaskets used are non-metallic, spiral-wound and ring-joint type (Fig. 4.8).

### Union

When two ends of pipes are joined, the pipe fitting used is called a union. A union is made of three parts, namely a nut, a male end and a female end. The male and female ends are assembled with the support of the nuts, and necessary pressure is applied to connect the joint. Since the pairing ends of the union are interchangeable, the union can be changed easily in a short time (Fig. 4.9).

### Reducer

It is used to connect pipes of different diameters. A reducer may be of various types like reducer tee, reducer elbow and reducer socket (Fig. 4.10).



Fig. 4.10: Reducers

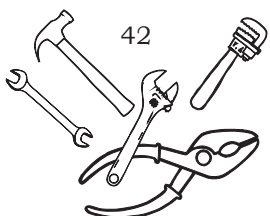

## Tee

It is an important fitting with a side outlet at 90° to the run of the pipe. Tees connect pipes of various diameters and help in changing the direction of water or material in a pipe. Tees are made in various sizes like equal or unequal. The equal tee is most commonly used (Figs. 4.11–4.13).



Fig. 4.11: Single tee socket

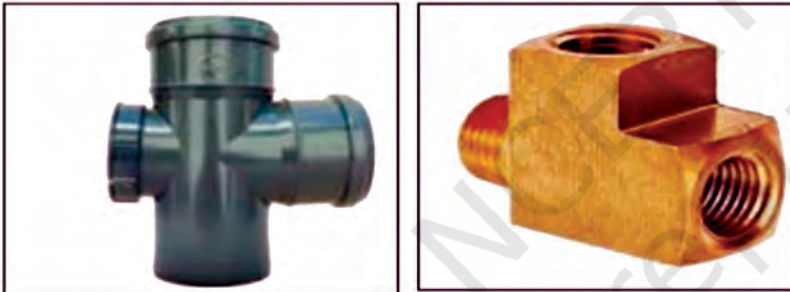

Fig. 4.12: Single tee socket



Fig. 4.13: Double tee socket

## Nipple

It is a piece of pipe having thread at both sides, and could be used for short extension of plumbing lines. It can also be used for connecting two fittings within small distance (Fig. 4.14).



Fig. 4.14: Nipple

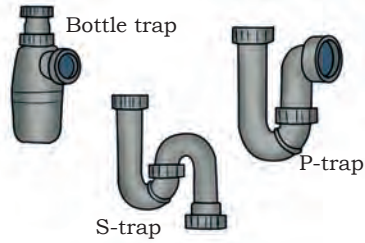

Fig. 4.15: Trap



Fig. 4.16: Cross



Fig. 4.17: Offset

## Trap

It is a fitting in a P-, U-, S- or J-shaped type (Fig. 4.15). Traps are fitted near a plumbing fixture. The trap bend is fitted to prevent sewer gases from entering the building. If the gases are inserted back into home, then it could lead to people inhaling foul smell, which could cause illnesses. It could even explode.

## Cross

When four pipes are joined, a cross is formed. It is also called a cross branch line or a four-way fitting (Fig. 4.16). This fitting has three outlets and one inlet. Cross fittings may deteriorate when temperatures change, because cross fitting is made at the centre of the four connection points.

## Offset

When an assembly of fittings on a pipeline makes one section of pipe out of line and parallel to a second section, then it is known as an offset (Fig. 4.17).

## Common sanitary fittings and fixtures

### Bathtub



Fig. 4.18: Bathtub

Installed in a bathroom, it is made of vitreous material, enamelled iron, plastic, marble, etc. Its length varies from 1.7 m to 1.85 m, the width is 70 cm×75 cm and the depth varies from 43 cm to 45 cm to the outlet end. Cold and hot water taps are provided for filling the tank, and an overflow pipe is provided for excess water drainage. A waste coupling with a waste seal trap is provided at the drain with a rubber plug as in the washbasin.

### Washbasin



Fig. 4.19: Washbasin

It is provided for washing hands, face, etc. These are generally made of vitreous china, burnt fireclay, ceramic, enamel over steel, marble, glass, etc. Washbasins are available in different shapes, sizes and colours.

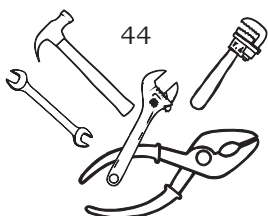

## Water closet

It is provided to receive human excreta directly from the user. It is connected through a suitable trap to the soil pipe and finally to a municipal sewer or septic tank. The excreta is flushed with the help of water from the cistern tank. There are two types of water closets.

1. Indian type
2. European type



Fig. 4.20: Water closet

## Faucet

It is a device that controls the flow of liquid, especially water, from a pipe. It is also called a water tap. It is available in a bathroom, kitchen or sink, as per use.



Fig. 4.21: Faucet



Fig. 4.22: Sink

## Sink

It is a rectangular, shallow, waterproof tank made of concrete, vitreous china, fireclay, or stainless steel. It is used for cleaning utensils, clothes, etc. The flow of a sink is provided with a hole for fixing a waste coupling and a waste pipe.



Fig. 4.23: Flushing cistern



Fig. 4.24: Geyser

## Flushing cistern

It is a small tank holding water for flushing urinals and water closets. It is made of cast iron, glazed earthenware, glazed vitreous, or any other material. Depending upon its size, a cistern can hold the following quantities of water—5 litres, 10 litres and 15 litres. A 10-litre cistern is the most common.

## Geyser

It is used for heating water. It is available in different capacities, upto 25 litres, as per requirement.

## Installation

It refers to the act of placing or fixing in position a plumbing fixture such as a washbasin, a water closet, etc. Installation is an important step in fixing the components of a system as per the design. During the installation of plumbing system in a building, home or a housing colony, planning is done as per the standard procedure of designing. A good installation system prevents water leakage, allows optimum installation of the money spent and enhances the life of the plumbing fixtures. Instructions for installation are given either by the manufacturer on one's own or the specifications in the construction map.

If the standard procedure is followed during the installation of plumbing system, it allows for smooth and efficient functioning of the system.

## Important points before installation

### **Read the plumbing drawing**

Study the drawing of the bathroom, washroom, kitchen or other places where installation is to be done. The drawing will help the Plumber General to understand various aspects of plumbing fittings, fixtures, distance and height to be maintained during installation.

### **Install the basic sanitary fixture**

Fittings (faucets and valves) are used more often than any other part of the plumbing system. The best modern fittings selected should use chrome-plated brass as it

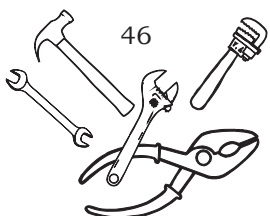



bears the effect of water quality and has a high durability. They can be cleaned easily with soap and warm water.

### ***Protection against backflow***

The supply lines and fittings for every plumbing fixture should be installed in such a way that there is no backflow. There may be a backflow due to improper design.

### ***Access for cleaning***

Plumbing fixtures should be installed in such a way that they can have easy access for cleaning, for both the fixture and the area around the fixture.

### ***Check for alignment and setting***

The fixtures must be set level in proper alignment with the adjacent walls. As per the Indian Plumbing Association Code, a water closet, lavatory or bidet should not be set closer than 15 inches (381 mm) from its centre to any sidewall, partition, vanity or other obstruction, or closer than 30 inches (762 mm) centre-to-centre between toilets or adjacent fixtures. An 18-inch (457 mm) distance must be in front of the water closet or bidet to any wall, fixture or door. Water closet compartments should not be less than 30 inches (762 mm) wide and 60 inches (1524 mm) deep. There must be at least 18 inches (457 mm) clearance in front of a lavatory to any wall, fixture or door. A urinal shall not be set closer than 15 inches (381 mm) from the centre of the urinal to any sidewall, partition, vanity or other obstruction, or closer than 30 inches (762 mm) centre-to-centre between urinals.

### ***Make floor and wall drainage connections***

Connections between the drain and floor outlet plumbing fixtures must be made with a floor flange. The flange shall be attached to the drain and anchored to the structure. Connections between the drain and wall-hung water closets should be made with an approved extension nipple or horn adapter. The water closet must be bolted to the hanger with corrosion-resistant bolts or screws. Joints should be sealed with an approved elastomeric gasket or setting compound.

## **NOTES**

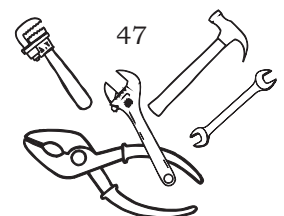

## NOTES

### ***Check for floor flanges***

Floor flanges for water closets or similar fixtures shall not be less than 1/8 inch (3.2 mm) thick for brass, 1/4 inch (6.4 mm) thick for plastic, and not less than a 2-inch (51 mm) caulking depth for cast-iron or galvanised malleable iron. Floor flanges of hard lead shall weigh not less than 0.7 kg and shall be composed of lead alloy with not less than 7.75 percent antimony (a chemical element which is a brittle, silvery-white metalloid) by weight. Closet screws and bolts shall be of brass. Flanges shall be secured to the building structure with corrosion-resistant screws or bolts.

### ***Secure floor outlet fixtures***

Floor outlet fixtures must be secured to the floor or floor flanges by screws or bolts of corrosion-resistant material.

### ***Secure wall-hung water closet bowls***

Wall-hung water closet bowls should be supported by a concealed metal carrier that is attached to building the structural members so that strain is not transmitted to the closet connector or any other part of the plumbing system.

### ***Make water-tight joints***

All the joints of fixtures close to the wall or floor must be sealed to prevent water from entering or passing through.

### ***Plumbing in mental health centres***

In mental health centres, pipes or traps should not be exposed, and fixtures must be bolted through walls.

### ***Design of overflows***

Where any fixture is provided with an overflow, the waste should be designed and installed in such a way that standing water in the fixture will not rise in the overflow when the stopper is closed, and no water will remain in the overflow when the fixture is empty.

### ***Connection of overflows***

The overflow from any fixture should be discharged into the drainage system on the inlet or fixture side of the

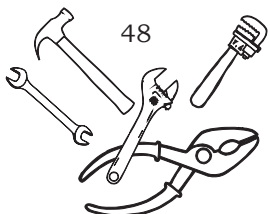

trap. The only exception exists in case of the overflow from a flush tank serving a water closet or urinal, which should be discharged into the fixture served.

### **Access to concealed connections**

Fixtures with concealed slip-joint connections should be provided with an access panel or utility space at least 12 inches (305 mm) in its smallest dimension or other approved arrangement so as to provide access to the slip connections for inspection and repair. Where such access cannot be provided, access doors shall not be required, provided that all joints are soldered, solvent cemented or screwed so as to form a solid connection.

### **Installation of a wall hung fixture**

**Step 1.** Install the mounting board between the studs at the proper height, using the same method as for a wall-hung flush tank.

**Step 2.** Attach a hanger bracket on the finished wall using the proper length of wood screws at the recommended height. The metal bracket must be level.

**Step 3.** Place the lavatory on the bracket and push down. Make sure the lavatory is level.

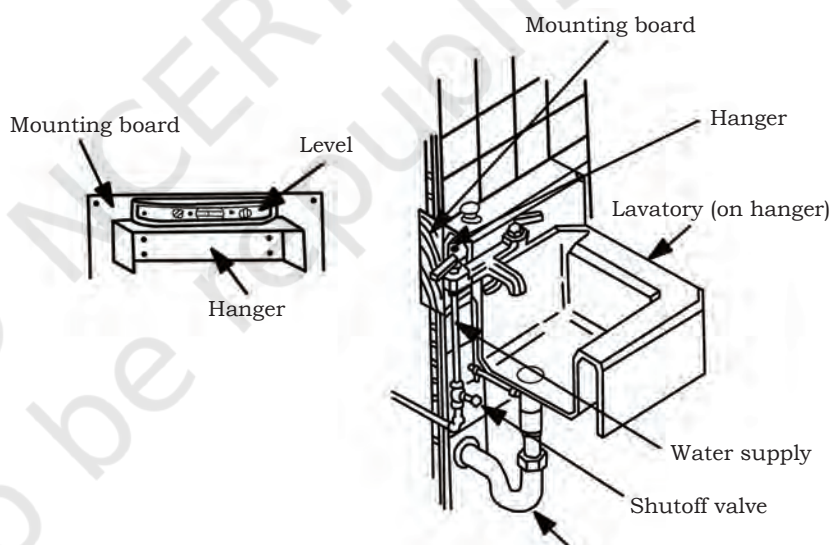

Fig. 4.25: Wall-hung lavatory installation

### **Joining of pipes**

Proper solvent cementing techniques are fundamental to the successful installation of pipes. Such techniques provide the basis for strong and durable solvent cement joints.

### **Solvent cementing**

Also known as solvent welding, solvent cementing is a chemical process that uses a primer, or the

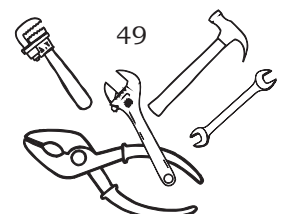

## NOTES

cement itself, to soften the surface of a plastic pipe and fittings in order to weld, or fuse them together. When applied, the solvents soften and dissolve the top layer of the pipe and fitting material, loosening its molecular structure. A taper in the fitting socket creates an interference fit that ensures contact between the pipe and fitting. This allows the material to fuse to itself when the two pieces are connected. Solvent cementing is a fast, easy and highly reliable process that produces a joint, stronger than either the pipe or fitting alone.

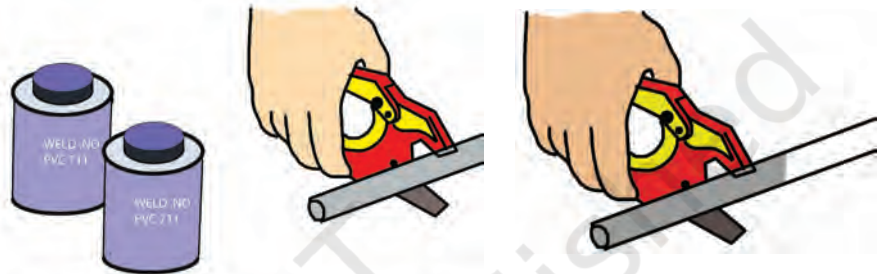
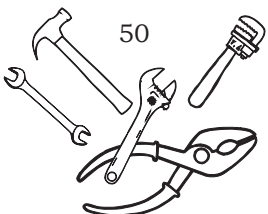

*Fig. 4.26: Solvent cementing is the most popular kind of Chlorinated Polyvinyl Chloride joining method*

PVC glue is used as a solvent cement. It is an adhesive that is used to create an airtight seal that holds the PVC pipe and connection fittings together. Considering that the majority of piping installation failures are the result of improper cementing techniques, an understanding of the proper techniques required for joining, saves both time and money.

### Procedure for solvent cementing

1. Inspect the pipe and fittings for overall appearance and compatibility. Obvious defects such as cracks, burrs and incompatible materials must be addressed as required. The joining surfaces must be clean and dry. In addition, the cement for the type and size of pipe and fittings should be determined. Also, remember both temperature and humidity may be issues to consider. Another detail that is often overlooked is the need to have the correct size applicator for the size of pipe. The size of the applicator should be about half the size



of the pipe diameter in order to ensure proper and timely solvent cement coverage.

2. Cut the pipe with a cutter or saw in square to provide optimal bonding area. See Fig. 4.26.
3. De-burr the pipe with a chamfering tool or file to ensure proper contact between pipe and fitting. Remove all burrs from both the inside and outside of the pipe with a knife, file or reamer. Burrs can scrape channels into pre-softened surfaces or create hang-ups inside surface walls. Remove dirt, grease and moisture. A thorough wipe with a clean dry rag is usually sufficient.
4. Apply a heavy, even coat of CPVC primer (if necessary) to the fitting. Use the right applicator for the size of pipe or fittings being joined. The applicator size should be equal to 1/2 the pipe diameter. It is important that a satisfactory size applicator be used to help ensure that sufficient layers of cement are applied.
5. Apply a heavy, even coat of primer (if necessary) to the pipe end. The purpose of a primer is to pierce through and soften the surfaces so they can fuse together. The proper use of a primer and checking its softening effect provides assurance that the surfaces are prepared for fusion in a wide variety of conditions. Check the piercing or softening on a piece of scrap before you start the installation or if the weather changes during the day. Using a knife or other sharp object, drag the edge over the coated surface.

Proper piercing has been made if you can scratch or scrape a few thousandths of the primed surfaces away. Because weather conditions do affect priming and cementing action, repeated applications to either or both surfaces may be necessary. In cold weather, more time is required.



Fig. 4.27: Joining of elbow after application of solvent

## NOTES

6. Apply a heavy, even coat of CPVC cement (if necessary) to the fitting. Then apply to the pipe-end. Stir the cement or shake can before using. Using the proper size applicator for the pipe size, aggressively work a full even layer of cement onto the pipe-end equal to the depth of the fitting socket. Do not brush it out to a thin paint type layer, as this will dry within a few seconds.
7. Insert the pipe into the fitting socket, rotating  $\frac{1}{4}$  to  $\frac{1}{2}$  turn. Hold the pipe for 10 seconds, allowing the joint to set. A merit of using plastic pipes is that if you make a mistake, you can cut the section out and re-do it.
8. The joining is finished. The cure (drying) time depends on pipe size, temperature and relative humidity. If local codes permit, successful joints can be made without a primer using cement alone, but extra care must be taken during the installation. It is important that a good interference fit exists between the pipe and fittings. It is for this reason that we recommend that joints being made without a primer be limited to systems 2" and smaller for pressure applications (water systems only) or 6" and smaller for drain waste vent (DWV) or non-pressure applications. Extra care must also be taken in applying the cement to make sure proper piercing (insertion) and softening of the pipe and fitting surfaces is achieved.
9. Joint strength develops as the cement dries. In the tight part of the joint, the surfaces will tend to fuse together; in the loose part, the cement will bond to both surfaces. These areas must be softened and pierced through. Piercing and softening can be achieved by the cement itself, by using a suitable primer or by the use of both primer and cement. For certain materials and in certain situations, it is necessary to use a primer. A suitable primer will usually slip into and soften the surfaces more quickly than cement alone.

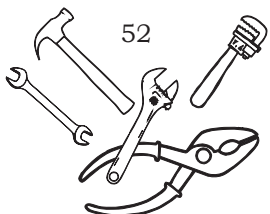

## Practical Exercises

### Activity 1

Visit a local sanitary shop and identify various types of plumbing fixture.

#### Material required

1. Pen
2. Pencil
3. File

#### Procedure

1. Visit a sanitary store.
2. Identify various plumbing fixtures available there and make a list.
3. Ask for the price and technical details (size, capacity, make) of the fixtures and note down in your file.
4. Collect pamphlets of the same, if available.

### Activity 2

Practise joining pipes using plumbing tools.

#### Material required

1. Joints
2. Pipe
3. Tools—hacksaw, cutter, brush, clamp
4. Adhesive

#### Procedure

1. Collect the pipe joints, pipes and tools—hacksaw, cutter, brush and clamp.
2. Identify the parts to be joined.
3. Collect the joints.
4. Join the pipe with help of a pipe jointing adhesive.

### Activity 3

Identify the various fixtures and fittings used in the bathroom and toilet.

#### Material required

1. Pen
2. Pencil
3. File

#### Procedure

1. Go to your bathroom and toilet.
2. Identify the fixtures and fittings used there.
3. Make a list of these in your practical file.

## NOTES

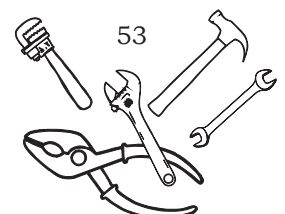

**Check Your Progress****A. Answer the following questions**

1. Explain the different fittings and its uses in the plumbing system.
2. Enlist the different fixtures and its uses in the plumbing system.
3. Write the important steps for the installation of plumbing fixtures.
4. Explain the procedure of pipe joining.

**B. Fill in the blanks**

1. Water closet, lavatory or bidet shall not be set closer than \_\_\_\_\_ inches.
2. Closet screws and bolts shall be of made of \_\_\_\_\_.
3. \_\_\_\_\_ should be accomplished by using a file or a chamfering tool.
4. The supply lines and fittings for every plumbing fixture shall be installed so as to prevent \_\_\_\_\_.

**C. Multiple choice questions**

1. A good installation system
  - (a) prevents water leakage
  - (b) allows the optimum utilisation of the money spent
  - (c) enhances the life of the plumbing fixtures
  - (d) All of the above
2. The length of a bathtub varies from \_\_\_\_\_.
  - (a) 1.7 m to 1.85 m
  - (b) 1.0 m to 1.15 m
  - (c) 1.2 m to 2.0 m
  - (d) 1.5 m to 1.8 m
3. The full form of CPVC is
  - (a) Chlorinated Polyvinyl Chloride
  - (b) Chlorinated Pipevinyl Chloride
  - (c) Chlorinated Polyvinyl Chlorine
  - (d) Chemical Polyvinyl Chloride
4. Geyser is used for
  - (a) heating the water
  - (b) cooling the water
  - (c) storing the water
  - (d) None of these

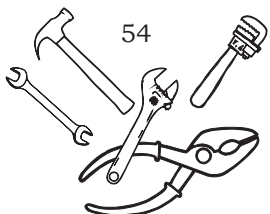



Unit



# Repair of Leakages in Basic Fittings and Fixtures

## INTRODUCTION

A water leak can cause a major disturbance in the plumbing system. Leaks from water pipes, plumbing fixtures and fittings are a sizeable source of water wastage in our homes. Sometimes, considerable water leakages from the system may cause problems related to pressure moulding and significant water losses. Thus, as soon as a leak is found, its repair becomes an absolute necessity.

When you find a leakage in the plumbing fixtures, it is necessary to repair it as soon as possible to avoid damage to structures or surroundings, and to possibly make it cost effective in the long run.

Some leaks can be visible, and some cannot be seen with the naked eye. The result could be an unusually high water consumption, which will also reflect in your water meter.

So, what causes a plumbing leak?

Old pipes, cold climate and other old plumbing fittings and fixtures like geyser and toilets may also cause leaks.

How do you detect the point of leakage? First, check those areas where leaking in fixtures is common, that is, joints. If the leak is inside the house, check the toilets, sinks, faucets, and showerheads. It is possible that the



171121CH05

## NOTES

leak is minor enough for you to notice it. Leaking toilets and kitchen faucets are the most common and most unnoticed leaks.

Even when you cannot see a leak in the pipes, you might be able to hear or observe it. Move slowly to each and every point of the distribution system, starting from the lowest level and working your way up. Listen to the pressurised sound of water or dripping. Look for a small pool of liquid or water stain under the floor or up on the ceiling. Water damage on wood panelling, cabinets, drawers, or wallpaper can all be signs of an 'invisible' leak too.

If the leak is from outside, we can check the spigots. Double check to make sure they are fully tightened. Listen for the sound of dripping or running water. Underground leakage can be found by a wet surface or swelled surface due to excessive moisture.

If you think you have found the leak and can get to it, you could try to fix the problem. Most toilet and faucet leaks can easily be fixed by replacing the O-ring or tightening the fixtures. If you can reach a fractured pipe, you could apply the plumber's tape as a temporary solution until you have the chance to change the pipe.

The various sources of visible and invisible leaks along with remedies have been discussed in this chapter.

If you find any of these, you will have to take immediate action to replace or repair before any further damage occurs.

### SOURCES OF LEAKAGE

#### Water supply line leaks

Sometimes, there are leaks in the water supply line coming to home from the meter. These are often difficult to detect because the supply pipe is usually buried at least 3 feet below the ground. Sometimes, the leaking water will travel along the pipe.

Another common exact point for the leaking water might be where the supply line rises above the ground and enters the house or building. If the soil is constantly damp at these locations, it might indicate a leak.

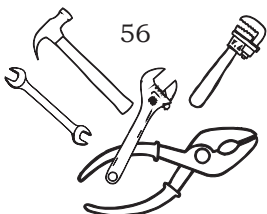

In case of sewer leaks, the water will seep up towards the ground surface, usually directly above the path of the underground pipe.

### Leaks due to pipe corrosion

Pipe corrosion is a process that results in a reduction of thickness of the wall of a metal pipe, caused by electrolysis (chemical breakdown by electric current), junk, or acidity of water. Galvanic corrosion (resulting from a direct current of electricity) is created in a plumbing installation system in which two different kinds of metal pipes are joined, such as galvanised and copper pipe.

The principal indication of corrosion might be a leak in the framework inside the walls or floors of the structure. Water may appear a few dimensions beneath the leak. Use a piece of wood as a resonator to recognise and amplify the sound of the leak. Spot one end of the wood against your ear and the opposite end against the pipe and follow the sound. There will be more sound while drawing nearer to the leak.

### Remedies

#### **Galvanised pipes**

After locating the leak, cut and replace the corroded pipe.

**Step 1.** Close the water at the nearest valve below the leak, and drain the pipe.

**Step 2.** When the fittings on both sides of the leak are not readily available, cut out the leaking section. One plumber should hold the pipe with a wrench to prevent its turning in the adjoining fitting, while another plumber cuts a thread on it.

**Step 3.** Replace the cut-out section with a desired coupling, a pipe section of the given length, and a similar union.

#### **Copper pipes**

Copper pipe resists corrosion, except when attacked by acids.

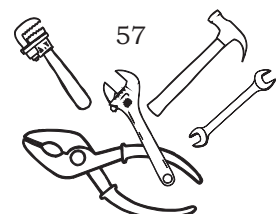

## NOTES

However, if a leak occurs in the copper pipe, then the steps listed below must be followed.

**Step 1.** Close the water at the nearest valve below the leak, and drain the pipe.

**Step 2.** Replace it with either soldered or compression joints.

We can also go with some more alternatives before and after, to prevent leakage. It can also be achieved by reducing corrosion. The following can be done to reduce corrosion.

### ***Use of di-electric unions***

These are fixed in the hot and cold water take-offs from the tank and it reduces the galvanic corrosion of water tanks. A di-electric union consists of a fibre washer, which shields or insulates the tank from the rest of the plumbing installations, preventing the flow of current from the tank to the system.

### ***Use of magnesium rods***

These are also used in a few geysers, such as the gas-operated type, to save against rust and corrosion. They act as electrolytic cells in which the magnesium dust goes into the solution, flows through the water, and is stored on the metal to be protected. The electrolytic action (electrolysis) diffuses the rods. The maximum life of the rods is 1½ years; then they must be changed.

### **Leaks in valves**

All valves should be checked regularly for leaks. Most leaks are from washers or bonnets.

### **Leaks in faucets**

A faucet is a device that allows you to turn the flow of water on and off. Since faucets help dispense water, thus, keeping them in working condition is very important. The typical causes for a leaky faucet include corrosion, mineral deposit on the internal parts or defective gaskets, O-rings or washers. Before repairing any faucet, drain it by turning the water off at the fixture of the shut-off valve.

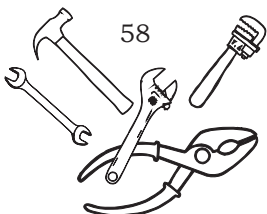

## Compression faucets

These faucets have separate hot and cold water handles and their action requires you to tighten the handle down to turn the water flow off. Such faucets use a compression stem, which is a type of screw with a washer at the end of it pressing against a valve seat.

While repairing compression (or washer) faucets, first check the valve seat. If it is chipped or rough, reface it with a refacing tool or replace it.

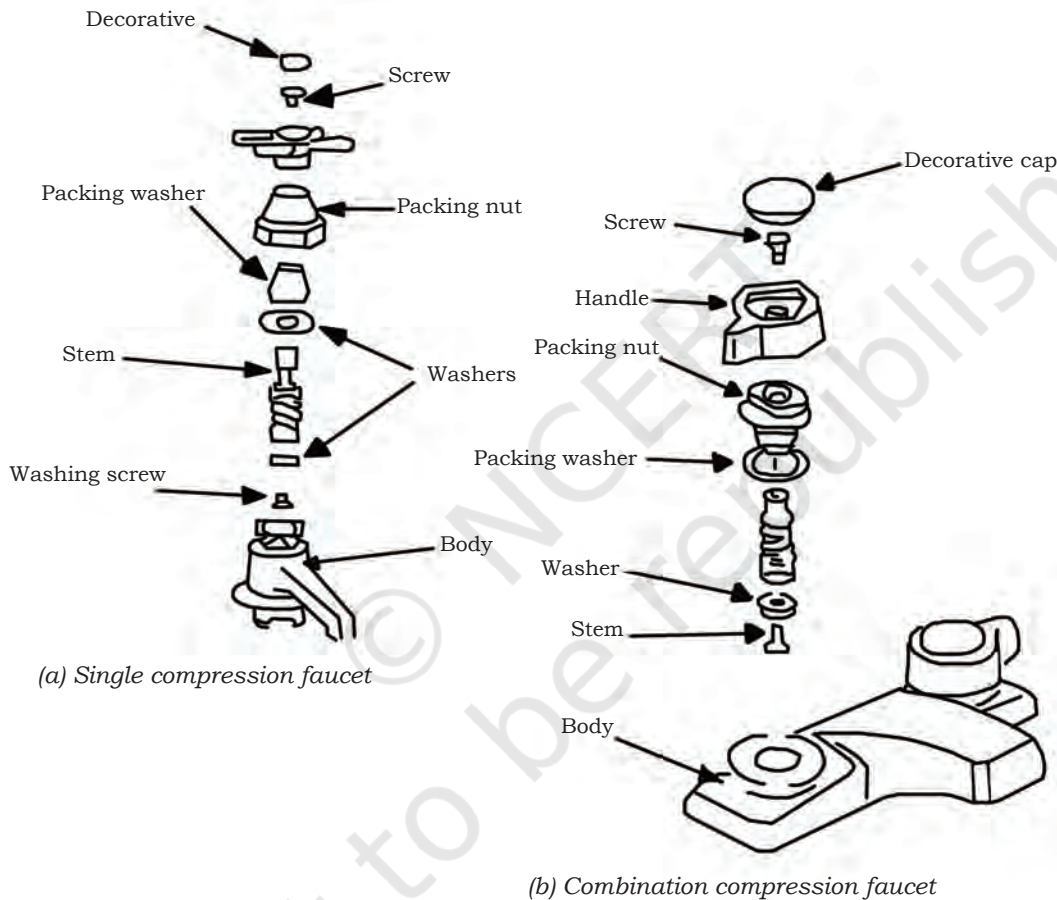

Fig. 5.1 (a, b) Compression faucets

Use the following procedures to repair single compression faucets. During disassembly, check all parts for wear and replace as needed.

### **Leak at the stem and the packing nut and washer**

**Step 1.** Turn the water supply off at the shut off valve, and remove the cap, screw and handle.

## NOTES

**Step 2.** Remove the packing nut with a wrench, the old packing material and the washer.

**Step 3.** Place a new washer onto the stem's lower end, and reassemble all parts in order.

**Step 4.** Turn the water supply on and check for leaks and proper operation.

### ***Leak at the spout***

**Step 1.** Turn the water supply off at the shut-off valve. Remove the cap, screw and handle.

**Step 2.** Remove the packing nut with a wrench; then remove the stem from the body.

**Step 3.** Remove the screw and washer from the bottom of the stem.

**Step 4.** Place a new washer onto the bottom of the stem.

**Step 5.** Check the valve seat inside the body. If it is chipped or rough, reface the seat with a refacing tool. If the seat is even, place the stem into the body. Replace if needed.

**Step 6.** Reassemble all the parts in the proper order.

**Step 7.** Turn the water supply on and check for leaks and proper operation.

### ***Leak at the base of the body***

**Step 1.** Turn the water supply off at the shut-off valve. Remove the cap, screw and handle.

**Step 2.** Remove the packing nut with a wrench.

**Step 3.** Remove the worn washer from the packing nut.

**Step 4.** Slide a new washer into the packing nut for a snug fit.

**Step 5.** Reassemble the parts in the proper order.

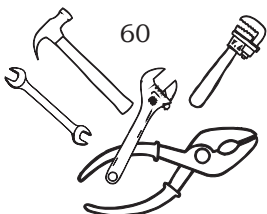

**Step 6.** Turn the water supply on and check for leaks and proper operation.

NOTE: Before repairing a faucet, drain it by turning the water off at the shut off valve. During disassembly, check all parts for wear and replace as needed.

**NOTES**

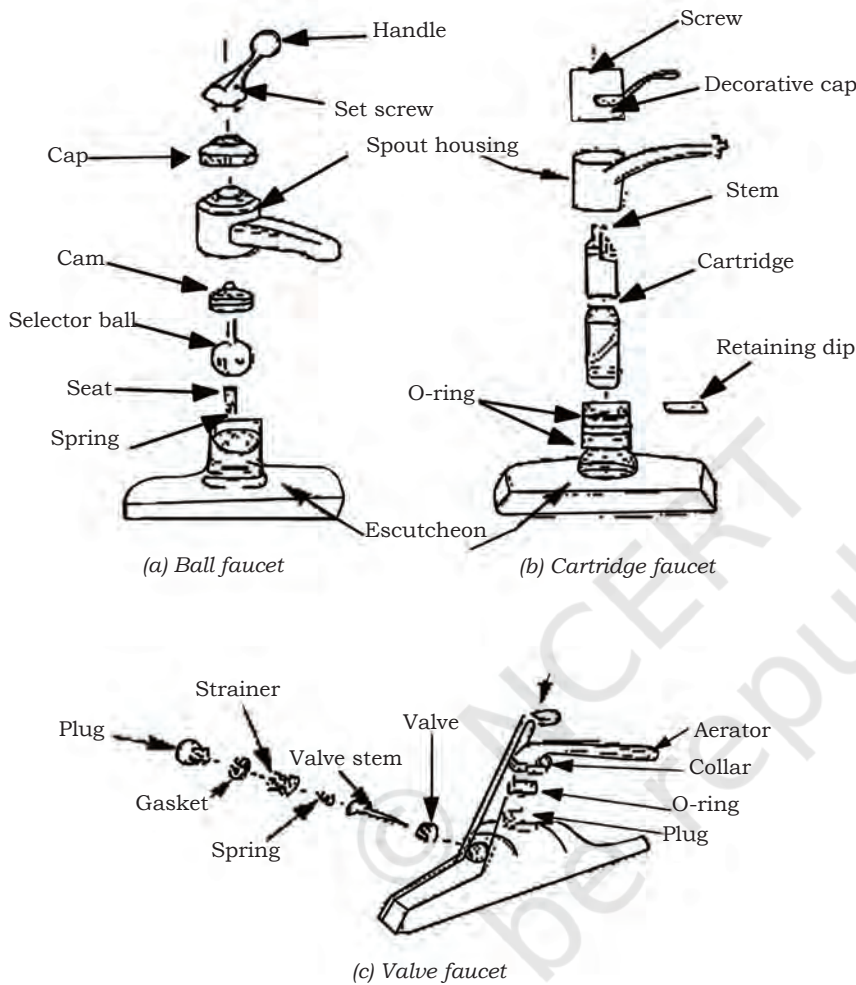

Fig. 5.2 (a, b, c) Components of faucets

**Non-compression faucet repairs**

**Ball faucets**

Commonly used in kitchen sinks, these washerless faucets can be identified by their single handle that regulates a special plastic or metal ball inside the faucet body. Because of the number of parts which make up this type of faucet, ball faucets tend to leak

## NOTES

more than other washerless faucets such as cartridge or disk faucet. Leaks in this type of a faucet can be caused by a corroded or gouged selector ball or by worn rubber valve seats.

**Step 1.** Remove the handle by loosening the set screw.

**Step 2.** Remove the cap and pull out the ball with the cam assembly.

**Step 3.** Use needle nose pliers to remove the two rubber valve seats and springs.

**Step 4.** Replace the rubber seats and/or the selector ball.

**Step 5.** Reassemble the faucet, ensuring that the slot in the ball aligns with the metal protection on the housing. Check for leaks.

### ***Metal cartridge faucets***

Such faucets look quite identical to a compression washer faucet. However, the action to turn off the water flow is more smooth and consistent in such faucets. The faucet turns off without additional pressure being required as in case of a compression faucet. Leaks in these faucets are usually caused by two O-rings in the faucet body. Replacing the O-rings should eliminate the leaks.

**Step 1.** Remove the screw and push a screwdriver down the hole to keep the stem in place while removing the handle and cover.

**Step 2.** Unscrew the retaining nut and remove the spout. The body of the faucet is exposed to get to the O-rings.

**Step 3.** Replace the O-rings.

**Step 4.** Reassemble the faucet and check for leaks.

### ***Ceramic-disk cartridge faucet***

Such faucets can be identified by their single lever over a wide cylindrical body. The disk faucet mixes hot and cold

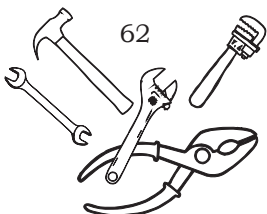



water inside a mixing chamber. Such faucets generally use in up-down motion to regulate water flow and left-right motion to control temperature. In the ceramic disk, leaks are caused by a worn out or corroded disk.

**Step 1.** Press the tile handle all the way back to remove the set screw.

**Step 2.** Remove the handle and the two set screws under the spout.

**Step 3.** Disengage the stopper mechanism under the lavatory and remove the ceramic cartridge, which is held by two brass screws.

**Step 4.** Replace the cartridge.

**Step 5.** Reassemble the stopper mechanism and the faucet. Check for leaks.

NOTE: If the faucet malfunctions due to corrosion or wear, use the manufacturer's instructions to make repairs.

### **Valve faucets**

Leaks in this type of faucet can be caused by a worn O-ring at the base of the spout or by other worn internal parts. See Fig. 5.2(c).

**Step 1.** Remove the spout and lift off the escutcheon. Remove the plugs on each side by turning them counter clockwise and pulling out the gasket, strainer, spring, valve stem, and valve seat.

**Step 2.** Remove the seat with a seat-removal tool or allen wrench.

**Step 3.** Reassemble the faucet and check for leaks.

### **Shower heads**

It is one of the main components of a shower that allows water to dribble through it. Shower heads deteriorate due to the following reasons.

#### **Mineral build-up**

This causes clogging, resulting in reduced water pressure.

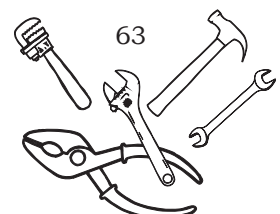

## NOTES

### Rust and leak

This reduces the life of the shower head, leading to reduction in pressure and unnecessary dripping. This creates the need to replace or repair the shower head.

### Procedure for changing shower heads

**1. Turn off the water**—First, turn off the main pipeline, which is normally located at the basement towards the front of the home or near the water tank.

**2. Clean the shower arm**—Use a toothbrush to clean the shower arm's threads.

**3. Install the shower arm**—Wrap the head of the shower arm in teflon or pipe-thread tape and screw it into the pipe opening in the wall or ceiling.

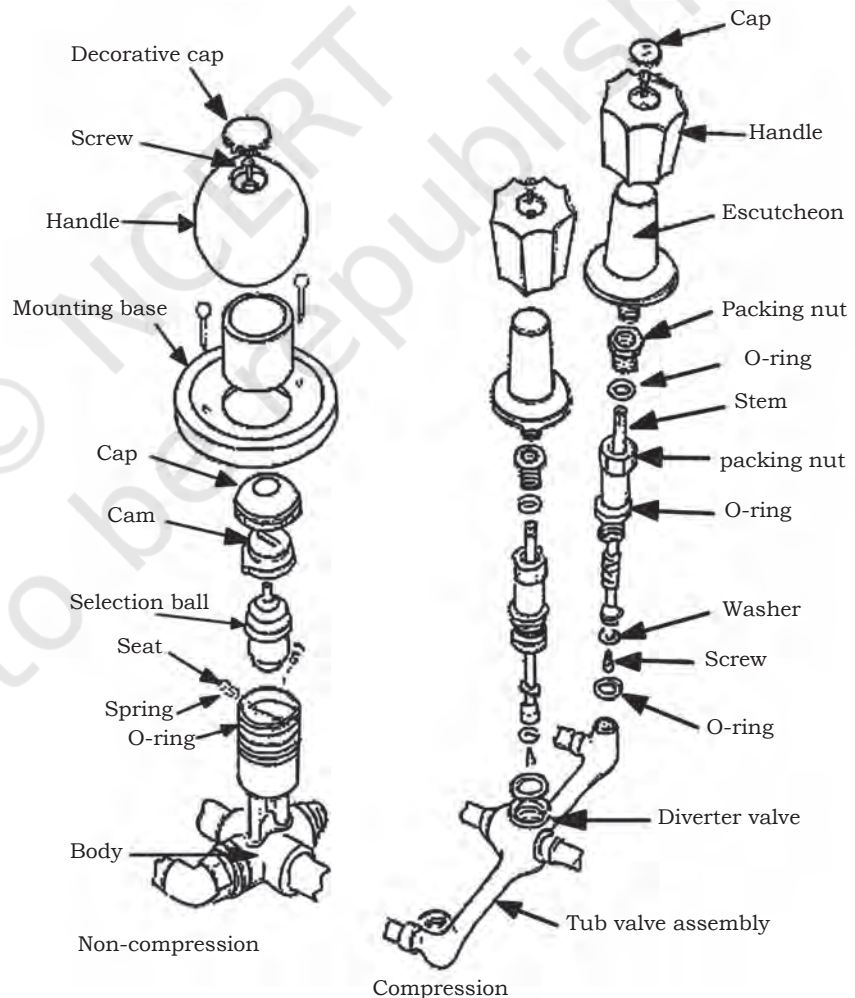
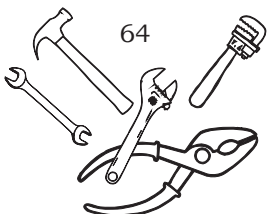

Fig. 5.3: Bathtub and shower faucet breakout



**4. Prep the shower arm**—Slide the backing onto the shower arm and wrap the open end in tape.

**5. Install the shower head**—Screw on the shower head by hand until it is snug. Wrap the shower arm and head in rags and use adjustable wrench to tighten the shower head further.

## Shower faucets

These faucets function the same as compression and non-compression faucets on sinks and lavatories. Although bathtub and shower faucets are developed differently than sink and lavatory faucets, yet the repairing methods are similar.

Showers use various types of faucets. These include—

1. Single-handle/single valve faucet
2. Double-handle faucet
3. Three-handle faucet

### Single-handle faucets

Single-handle faucets are commonly used. Valve cartridges in faucets are cylindrical devices that use O-rings to control the flow of water. Replacement is the easiest way to fix cartridge-related problems. The procedure to replace single-handle faucet is given here.

1. Turn off the water.
2. Locate the set screw under the handle or cap at the front of the unit. Remove the screw and pull.
3. Use a screwdriver to remove the retainer clip at the top of the cartridge housing. Be sure not to lose this piece.
4. Remove the cartridge by gently pulling with pliers.
5. Take the old cartridge to the hardware store to ensure you get the right replacement. Cartridges are specific to faucet make a model.
6. Insert the new cartridge.
7. Replace the retaining clip and reassemble your faucet. Turn the water back on to make sure your faucet does not leak.

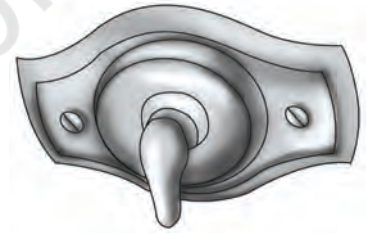

Fig. 5.4: Single-handle faucet

## Two-handle faucet

These faucets also have a mechanism that uses threaded handles and rubber seals to open and close water lines (Fig. 5.5). Installing a new stem is the easiest way to fix a malfunction, but we can also replace faulty hardware like seals and O-rings.

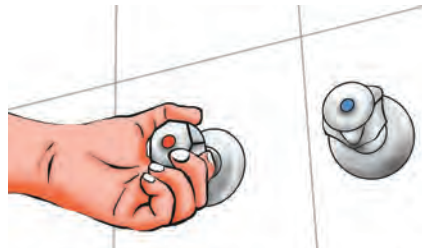

Fig. 5.5: Two-handle faucet

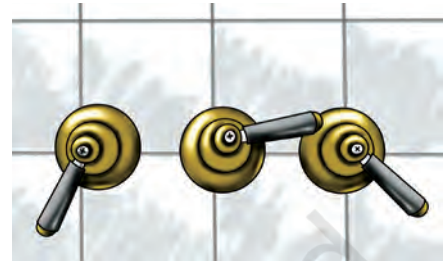

Fig. 5.6: Three-handle and diverter faucets

## Three-handle and diverter faucets

These faucets have temperature stems (hot and cold handles) and diverter stems (Fig. 5.6). The procedure for repair has been discussed below.

### Temperature stems

We can fix temperature stem issues the same way, we would a two-handle faucet.

1. Pry away the index cap at the front of the handle to access the handle screw. Remove the screw and pull. Use a handle puller if it is stuck. Use pliers or a deep-socket wrench to gently turn the stem counterclockwise.
2. Wrap teflon tape around the base of your stem and screw it into place.
3. Replace the handle hardware.

### Wall diverter stems

This is usually the third handle in a three-handle valve. Replacing the faulty diverter valve is the easiest way to solve the problem. The steps to replace are given here.

1. Remove the cap and handle as in the single handle guide. Gently remove it, being careful not to mar the finish.
2. With a socket wrench, remove the old valve.

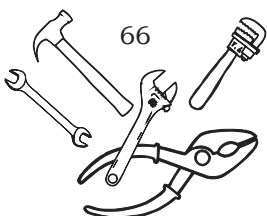

3. Wrap teflon tape around the threads of the new valve, leaving the first few threads bare to ensure a grip.
4. Insert the new diverter and give it an extra quarter turn after it is tight. Do not force it.
5. With the handle, turn it and test the water to make sure it only comes out of where it is supposed to. This is also a good time to shine a flashlight into the valve and make sure there are no leaks.
6. Reassemble the diverter handle.

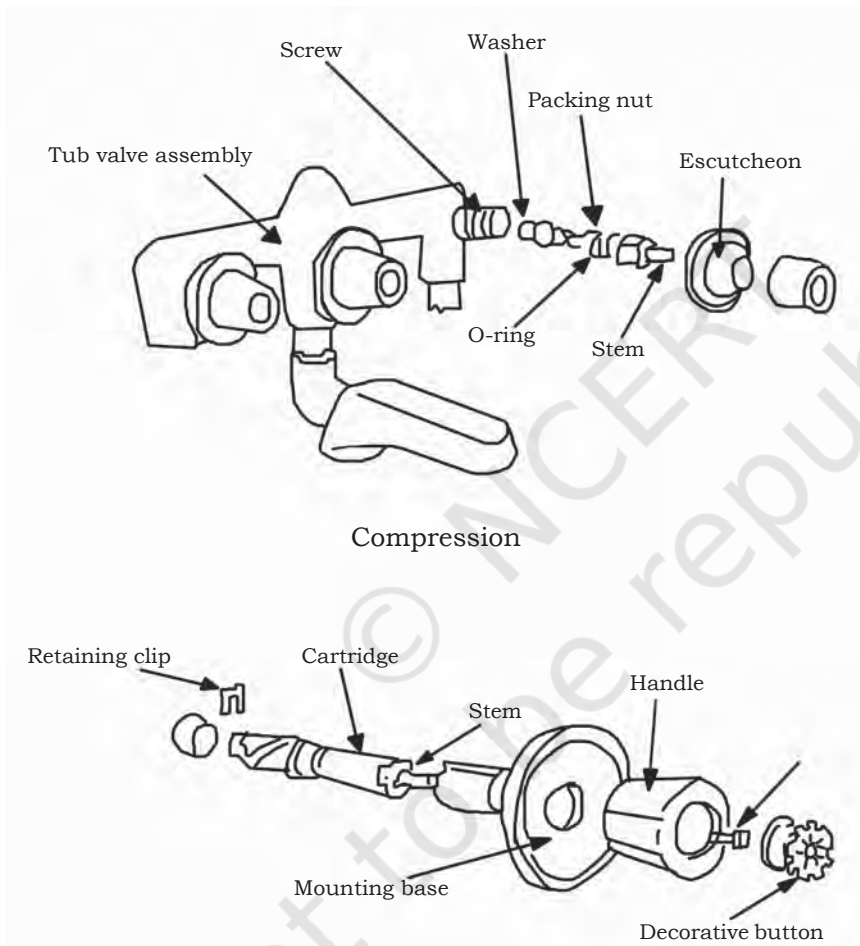

*Fig. 5.7: Bathtub faucet breakout*

It is important to ensure you routinely monitor any minor water leaks at home. This will prevent damages that will be costly to repair as well as lower our water bill. If you still cannot repair leakage due to severity of damage and it is required to stop leakage on urgent basis, we might look for some of the temporary repairs.

## NOTES

Remember to not risk a serious injury in trying to inspect or repair it.

### Repair of bathtub faucet

The following steps are to be followed for the repair of a bathtub faucet.

**1. Disassemble the faucet**—Removing the faucet handle is a difficult task. Due to corrosion, the handle gets jammed or weld the handle to the stem. Close the water supply to the faucet and open the valves to drain excess water present in faucet or tap. With the help of a thin blade of a pocketknife loosen the handle screw.

**2. Remove the handle screw**—Remove the handle screw. Then give a little jerk to the handle and pull it off. However, be gentle; if it is too hard, it may break, use a gentle push.

**3. Loosen the handle**—When the handle is not able to come out and we use force, it may break. Thus, use a special handle puller. Rotate the handle screw about halfway back into the stem. Fix the handle puller's post against the screw head and press the arms together behind the handle. Turn the post clockwise until the handle pops loose. Remove the handle screw and handle. Then pull off or unscrew the escutcheon plate.

**4. Remove the stem**—When the handle is removed, unscrew the escutcheon and stem assembly. The stem assembly is an important component which controls the amount and temperature of the water dispensed through the tub spout or shower head. The stem assembly is removed with a special bath socket wrench. Fix the bath socket with the stem bonnet and turn it counter clockwise so that it gets loosened. Unscrew and remove the stem.

**5. Use a seat wrench**—As you understand that leaks usually occur for two reasons, first the seat washer stiffens and would not seal properly. Sometimes, the water pressure gradually erodes the brass rim of the seat. Replace the seat using a special seat wrench.

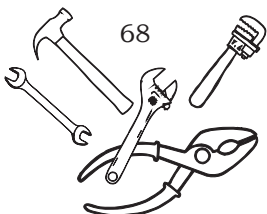

**6. Replace the faucet stem parts**—Change the broken washer and apply.

### Temporary repairs for minor leaks

Minor leaks in a fixture require temporary or emergency repairs. Before making any repairs, turn off the water and relieve the pressure from the distribution system. Pipes can be temporarily repaired using the following steps.

#### Rubber hose or plastic tubing

Cut the pipe on either side of the leak with a hacksaw or pipe cutter. The section damaged pipe may be removed and replaced with a similar length of rubber hose or plastic tubing. To do this, slip the ends over the pipe and fasten them with hose clamps. The inside diameter of the hose must fit the outside diameter of the pipe.

#### Sheet rubber

Wrap the leaking area with sheet rubber. Place two sheet-metal clamps on the pipe (one on each side). Then, fasten the clamps with nuts and bolts.

#### Electrician's friction tape

Wrap several layers of friction tape around the hole or crack, extending the tape about 2 inches above and below the leak.

#### Wood plugs

Small holes can be filled with wood plugs. Drive a wooden plug into the hole after it is drilled or reamed. The plug will swell as it absorbs water, preventing it from being blown out by water pressure.

NOTE: It is always recommended that repair should be made as soon as possible to permanently replace the broken, weak or defective part. Replace it with a unit (and insulation if used) that is the same size and quality as the original installation.

### Frozen pipes

Water supply lines may freeze when exposed to temperatures below zero degrees Celsius. Outside pipes must be buried below the frost line. In northern zones,

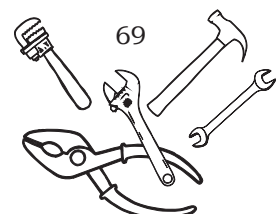

## NOTES

this may be 4 feet or more. If the temperature of a building deviates below freezing, inside pipes may also freeze, causing the pipe to break at the lowest point. Procedures for thawing above- and below-ground pipes are discussed in the paragraphs below.

### Exposed pipes

A blowtorch is the best method to thaw the above-ground pipes, but there is a risk of fire. Use the following steps when using a blowtorch.

**Step 1.** Open the faucets in the line.

**Step 2.** Apply heat from the blowtorch at one end of the pipe and work along the entire length of the pipe.

**Step 3.** Continue to heat the pipe until the water starts to flow freely.

Pipes can be thawed by wrapping them with burlap or other cloth and pouring boiling water over the wrappings, thus transmitting heat to the frozen pipe.

When internal freezing is due to a failure in the heating plant, the heating plant must be repaired; a high temperature should be maintained in the building until the pipes thaw.

NOTE: Do not overheat as the solder joints will break loose when the solder melts.

### Underground pipes

Use the following steps to thaw a frozen underground pipe.

**Step 1.** Remove the pipe fittings.

**Step 2.** Place a small warm up pipe or tube into the frozen pipe.

**Step 3.** Add an elbow and a piece of vertical pipe to the outer end of the warm up pipe.

**Step 4.** Keep a bucket below the opening to the frozen pipe.

**Step 5.** Insert a funnel into the open end of the vertical pipe.

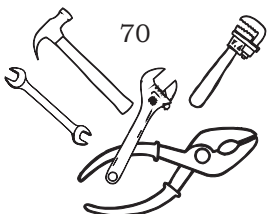



**Step 6.** Pour boiling water into the funnel and as the ice melts, push the thaw pipe forward.

**Step 7.** After the flow starts, withdraw the pipe quickly. Allow the flow to continue until the thaw pipe is completely withdrawn and cleared of ice.

NOTE: A small pump may be used to clear a piece of pipe. However, excessive pump pressure can cause a backup; therefore, this procedure must be carefully monitored.

## Scale

It is a deposit that is typically indicative of hard water. Scale can sharply reduce the flow of water to the fixtures. Calcium and magnesium compounds are found in hard water which prevent soap from lathering. This forms a scum, which slows down the flow of water. The scum deposits harden and form scale.

### Reducing scale

In localities where water is unusually hard, a water softener is used to reduce the hardness. The softener normally contains zeolite, which should be recharged at regular intervals. Add sodium chloride (table salt) to the water to recharge. Water softeners are programmed to recharge at a set time each day. The softened water is then piped into the distribution system.

### Removing scum

To remove scum that has formed on the inside of a pipe, do one of the following.

- Flush with hot water.
- Use lye, or lye mixed with a small quantity of aluminum shavings. Only cold water should be used with lye.
- Replace the entire pipe when there is a sharp reduction of water flow.

NOTE: Chemical cleaners should not be used in pipes that are completely stopped up because the cleaners must come in contact with the stoppage directly.

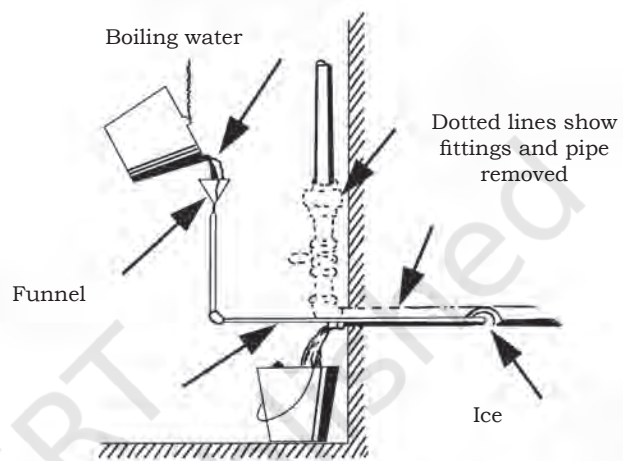

Fig. 5.8: Thawing frozen pipe

## NOTES

### Waste system stoppages

A common problem in waste systems is a stoppage of waste. This stoppage can occur in any drain, like, floor drain, branch line, or main line. It can be due to stone, pulp, hair, grease, or other foreign matter that holds back or stops the flow of waste disposal. Use the path clearing tools to clear the such stoppages in water closets, lavatories sinks, urinals, bathtubs, shower drains, branch, main waste lines, and grease traps.



(a) Force-cup plunger



(b) Water closet snake



(c) Cleaning the basin with a snake

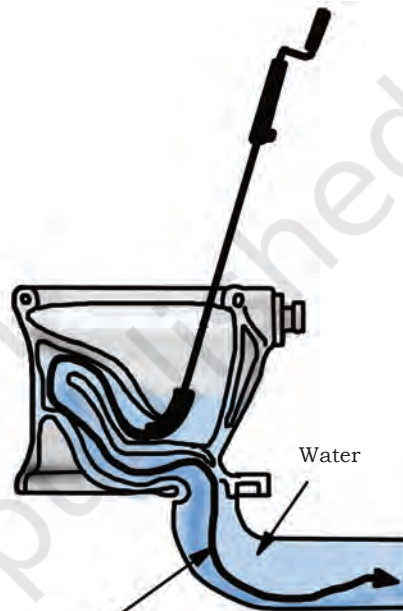

(d) Cleaning the toilet with a snake

Fig. 5.9 (a, b, c, d) Stoppage clearing tools

### Water closet stoppages

Such stoppages can be cleared using the following tools.

#### Force-cup plunger

Following are the steps to clear stoppages with a force-cup plunger.

**Step 1.** Pump the plunger up and down until the water level drops.

**Step 2.** Place toilet paper in the bowl and flush the water closet to check if the stoppage is cleared.

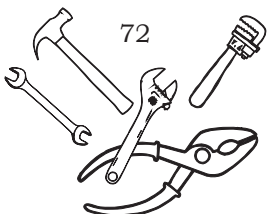

## Water closet snake

It is a long coil of wire with a corkscrew line tip that is inserted into the pipes till it reaches the stoppage. The following steps can be used to clear stoppages with a water closet snake.

**Step 1.** Push the snake into the bowl and turn the handle clockwise with a push-pull action until the water level drops.

**Step 2.** Check to see if the stoppage is cleared as in step 2 (like in the force-cup plunger above).

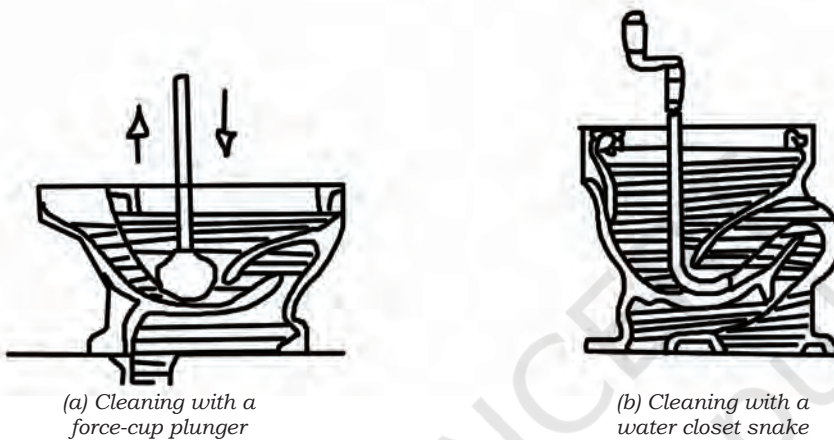

Fig. 5.10 (a, b) Clearing water closet stoppages

## Lavatories and sinks

### Clearing lavatory and sink P-trap stoppages

#### Plunger

**Step 1.** Place a wet rag in the bowl's overflow opening. If the lavatory has a pop-up plug, remove the plug.

**Step 2.** Set a plunger over the waste outlet and push it up and down until the water completely drains out of the bowl.

**Step 3.** Remove the rag from the overflow opening and replace the pop-up plug, if necessary.

**Step 4.** Run water through the drain to ensure that the stoppage is removed.

### **Snake (1/4- to 1/2-inch)**

**Step 1.** Remove the plug if the lavatory has a pop-up plug.

**Step 2.** Push the snake down into the waste outlet as far as it will go.

**Step 3.** Use a push-pull and turning action until the water completely drains out of the bowl.

**Step 4.** Remove the snake and replace the pop-up plug, if applicable.

NOTE: Stoppage in a P-trap can be removed by disassembling the P-trap, then removing the stoppage. Reassemble the P-trap after the stoppage is removed and flush with water to ensure good drainage of water.

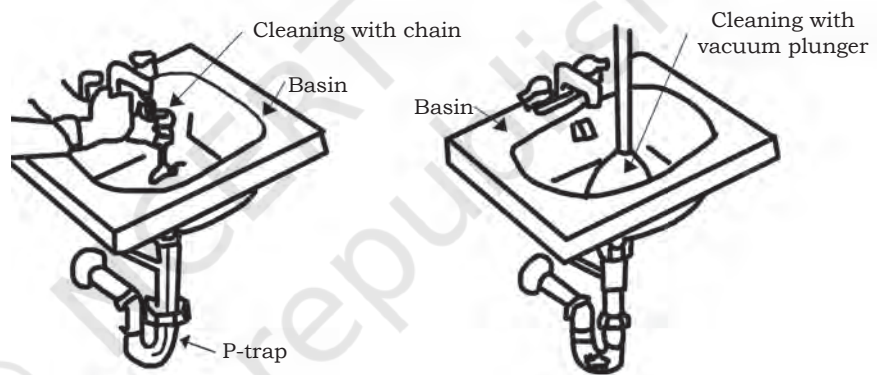

Fig. 5.11: Clearing lavatory and sink stoppages

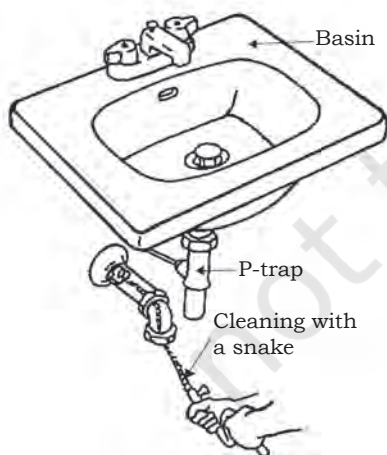

Fig. 5.12: Cleaning lavatory and sink stoppages beyond the P-trap

## Clearing lavatory and sink drain line stoppages beyond the P-trap

### **Snake**

**Step 1.** Place a container under the P-trap to catch the water spillage, then disassemble the P-trap.

**Step 2.** Push the snake into the drain line, turning it with a push-pull action until it moves freely.

**Step 3.** Remove the snake and replace the P-trap, then run water through the drain line to ensure that the water flows freely.

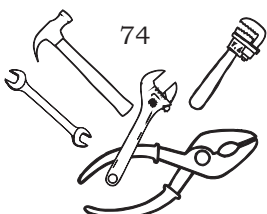

## Urinals

A stoppage in a urinal with a water seal or an exposed P-trap is cleared the same as a lavatory (using a plunger and a ¼- to ½-inch snake)

## Bathtubs

Use the steps below to clear bathtub P-trap stoppages.

**Step 1.** Remove the stopper linkage and the overflow cover.

**Step 2.** Push a ¼- to ½-inch drain snake into the overflow opening until it meets some resistance.

**Step 3.** Turn the snake using a push-pull motion until it turns freely.

**Step 4.** Remove the snake and run water through the drain to check if the stoppage is cleared.

**Step 5.** Replace the overflow cover and linkage.

NOTE: Stoppages can often be removed with a vacuum plunger. Try a plunger first; if the plunger does not work, use a snake.

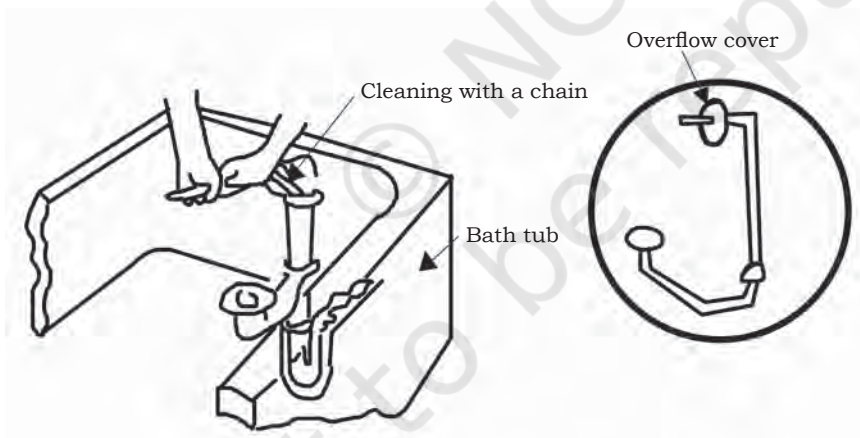
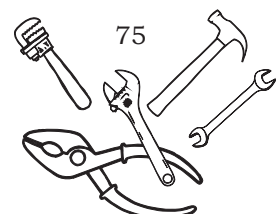

Fig. 5.13: Clearing bathtub P-trap stoppages

## Bathtub drum-trap stoppages

Use the following steps to clear drum-trap stoppages

**Step 1.** Remove the drum-top cover and gasket and push a ¼- to ½-inch snake into the trap's lower line to search for the stoppage.



## NOTES

**Step 2.** If a stoppage exists, clear it.

**Step 3.** If there is no stoppage in the lower line, remove the snake and push it into the upper line.

**Step 4.** Turn the snake with a push-pull action to remove the stoppage and replace the gasket and cover.

**Step 5.** Run water through the drain to see if the stoppage is cleared.

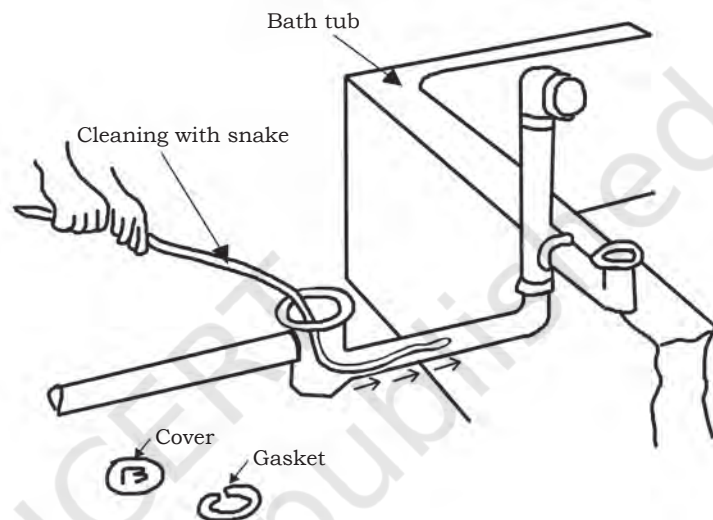

Fig. 5.14: Cleaning bath drum-trap stoppages

### Shower drains

These can be cleared by using a hose. Use the steps below to clear drains.

**Step 1.** Remove the strainer from the drain.

**Step 2.** Attach the water hose to a source of water and place the other end of the hose into the drain.

**Step 3.** Stuff rags around the hose to form a tight seal.

**Step 4.** Turn the water on full force, then off and on again. The surge of water (pressure) will clear the stoppage.

**Step 5.** Replace the strainer.

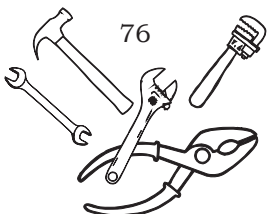

### **Snake ( $\frac{1}{4}$ - to $\frac{1}{2}$ -inch)**

**Step 1.** Remove the strainer from the drain.

**Step 2.** Push the snake into the drain and turn the snake with a push-pull action until it moves freely.

**Step 3.** Remove the snake and replace the strainer.

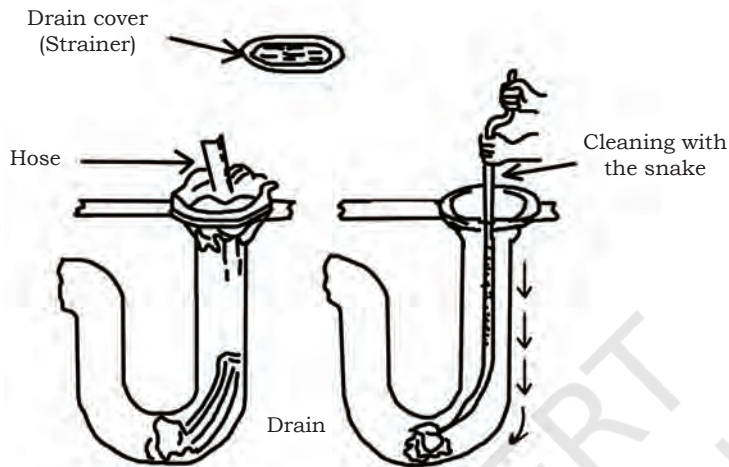

Fig. 5.15: Clearing shower-drain stoppages

### **Floor drain stoppage**

These stoppages are cleared the same way as shower drains. A floor drain may have the strainer cemented to the floor. If so, remove it by chipping the cement around the strainer. Once the stoppage is cleared, cement the strainer back in place.

### **Branch and main waste lines**

Stoppages that occur in a branch or main waste line in a building are cleared through a cleanout plug. Following steps may be adopted for clearing branch lines.

**Step 1.** Open and remove the closest cleanout plug.

**Step 2.** Clear the stoppage with a snake.

**Step 3.** Replace the cleanout plug.

### **NOTES**

## NOTES

**Step 4.** Run water through the drain to ensure that the stoppage is cleared.

Clear main lines by using the following steps:

**Step 1.** Remove the closest cleanout plug.

**Step 2.** Clear the stoppage with a  $\frac{3}{4}$ - to 1-inch heavy-duty snake.

**Step 3.** Replace the cleanout plug.

### Grease traps

All work is done on the principle that grease is lighter than water and will rise to the top of the water. Use the following steps to clear a grease-trap stoppage.

**Step 1.** Remove the top cover and dip out the grease with a ladle.

**Step 2.** Scrape the walls and bottom after the grease is scooped out.

**Step 3.** Flush with clear water.

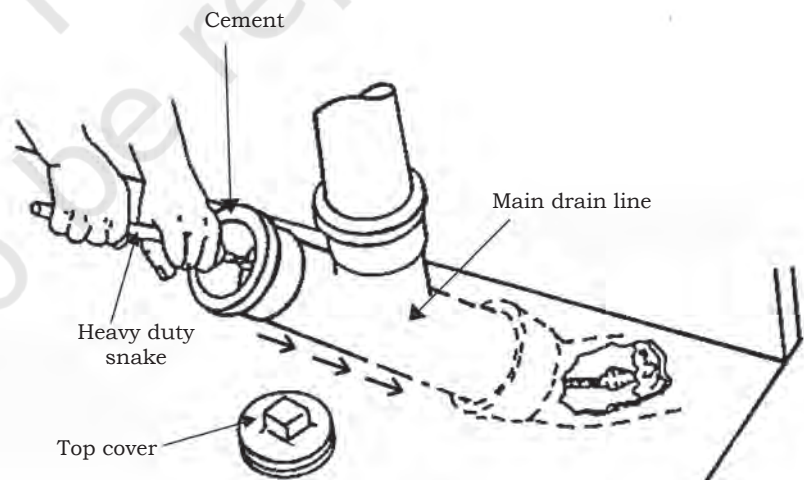
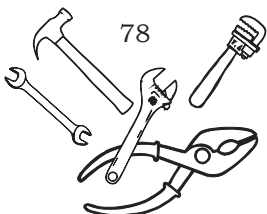

Fig. 5.16: Clearing waste-line stoppage





## Practical Exercises

### Activity 1

Draw the figure of a single compression faucet.

#### Material required

1. Pen
2. Pencil
3. Notebook
4. Single compression faucet

#### Procedure

1. Take a single compression faucet.
2. Observe it carefully
3. Now, draw its figure and label it.

### Activity 2

Identify the components of a ball faucet.

#### Material required

1. Pen
2. Notebook
3. Pencil
4. Ball

#### Procedure

1. Take a ball faucet.
2. Observe it carefully and try to identify its components.
3. Draw its figure.

### Activity 3

Identifying blockages at home.

#### Procedure

1. Ask your parents if there has been a blockage at home.
2. Discuss with them the extent of such a blockage and try to identify why it happened.

## Check Your Knowledge

### A. Answer the following questions

1. Explain the different sources of leakage.
2. Write the procedure for repairing of faucets.

## NOTES

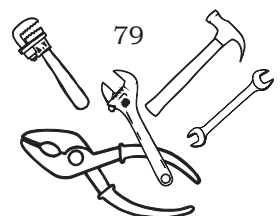

## NOTES

3. Discuss pipe corrosion. How can such a pipe be repaired?
4. What do you mean by frozen pipes?

### B. Fill in the blanks

1. Reduction in the thickness of wall of a metal pipe, caused by electrolysis and acidity of water is called \_\_\_\_\_.
2. A common problem in waste systems is \_\_\_\_\_.
3. \_\_\_\_\_ resists corrosion.
4. A corroded pipe can be replaced with \_\_\_\_\_ and \_\_\_\_\_ pipes.

### C. Multiple choice questions

1. Water leakage can happen \_\_\_\_\_ time.  
(a) always  
(b) any  
(c) ever  
(d) none of these
2. Pipe corrosion is \_\_\_\_\_ of the wall of metal pipe.  
(a) thinning  
(b) thickening  
(c) cutting  
(d) none of these
3. Magnesium rods are used to protect against \_\_\_\_\_.  
(a) cold  
(b) rust  
(c) heat  
(d) None of these
4. Water supply may freeze when temperature reaches below \_\_\_\_\_ degree Fahrenheit.  
(a) 0  
(b) 23  
(c) 32  
(d) None of these

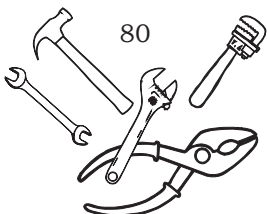

Unit



# Performing various Plumbing related Operations and Procedures

## INTRODUCTION

While carrying out plumbing repairs, it is important that the Plumber has sufficient knowledge of the cause of damage to the plumbing system. Some of the causes that must be kept in mind are listed below.



## Causes of damage to the pipeline and plumbing system

1. Defective jointing material
2. Direct strike on the body of the pipe with any sharp edge, while jointing
3. Slipping of jointing material, like rubber ring or lead, etc.
4. Corrosive nature of soil, causing damage to the external surface of the pipe
5. Loss of support or anchorage (horizontal or vertical), both in case of pipes embedded and those laid above the ground level
6. Movement of soil due to filled soil, mining
7. Movement of soil while work such as laying of pipes or cables, etc., is taken up
8. Changes in soil moisture or water table conditions

## NOTES

9. Expansion—severe compression, end crushing
10. Contraction—pull out or separation of joint
11. Pipe blockages and splits
12. Excessive test pressure
13. Pressure surge, water separation, vacuum
14. Extending pipe connections without proper precautions
15. Damage to the internal surface of pipe as well the lining material

The following procedure should be followed for the repair of pipes.

1. Location and demarcation
2. Repair planning
3. Repair work: selection of most appropriate method for repair
4. Testing of 'dry' repair
5. Restoration

### Steps for repair

1. Inspect the site and ascertain the nature of the failure.
2. Assess any possible damage that may arise and take steps to face such situations.
3. Investigate the access to the site so as to plan the arrangement of plant and equipment.
4. Locate isolating valves for proper control of requisite activities required for repair work

### Types of repair

A 'wet' repair is defined as a repair which can be achieved while maintaining a nominal pressure in the pipeline. Split collars or identical fittings can be installed in this way if the conditions are favourable.

A 'dry' repair is defined as one in which the main is completely isolated and drained out. It is necessary to stop water supply or make 'dry' main while cutting and replacing the defected portion. It will save the water from draining.

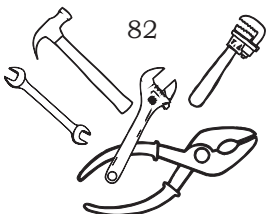

## Repair of small, local defects—‘wet repair’

For small local defects such as pinholes, a single split collar or wraparound clamp may be all that is required. The repair can be carried out as a ‘wet’ or ‘dry’ operation. In case of ‘wet’ repair, care should be taken to maintain a steady, gentle flow so as not to dislodge the sealing elements.

## Cut out—‘dry repair’

For a more extensive damage, for instance, a longitudinal fracture, a section of pipe is cut out and replaced by the use of two appropriate couplers. If the full extent of the fracture is not clearly defined, cuts should be made at least 300 mm beyond each end of the visible crack or defect. In case of any doubt, the full length of the damaged pipe should be replaced. This necessitates cutting out the joint at both ends of the affected pipe. Thus, the repair normally requires two replacement pipe sections and three couplers.

## Replacement repair

1. Carry out correct measurements and give allowance for expansion
2. All cuts should be made clean and square. This means that there must be uniformity in cutting and the cuts must be free from dirt and burr, etc.
3. In AC pipes, cuttings should be avoided.
4. All cut edges should be prepared to the manufacturer’s recommendations.
5. Both exposed ends of the existing pipe should be treated similarly.
6. Couplers should have their sealing rings lubricated, if recommended.
7. Correct expansion gaps should be allowed.
8. Good alignment is essential, particularly if narrow couplers are used.
9. All couplers and collars should be centralised.
10. Tighten all bolts evenly.

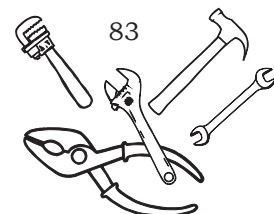

## NOTES

11. Do not overtighten bolts or compression joints.
12. Restore any damaged coatings on the parent pipe.
13. Ensure full protection to the bolts and any exposed bare metal before burial.

### Site management

#### Record of repair

While the repair is still visible, the details of repair should be recorded. This could include any leakage that may have been plugged or the change of pipeline, if any.

#### Site cleanliness

During the repair work, the area should be kept as clean as possible. All debris and contaminants should be removed from the site and the contamination of the trench from plant, equipment or any other potentially hazardous materials must be avoided.

#### Prevention of contamination during repair work

Clean and spray with disinfectant, on all surfaces that come into contact with potable water, including the broken main, repair fittings and replacement pipe. Ensure that the contaminants do not enter the main where it is cut for repair. After completing the repair, flush the main at the nearest hydrant to remove any dirt, etc.

#### Disinfection procedure

For small repairs which do not require the main to be cut, the fracture should be cleaned. This, along with the repair collar should be sprayed with disinfectant. For major repairs requiring cut-out, care must be taken to prevent contamination.

#### Clear site

On completion of the work, all material and protective barriers should be removed from the site and the working area should be left clean and tidy. All records of repair should be completed and submitted.

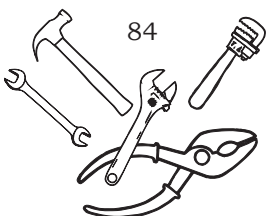

## Repair of fixtures

## NOTES

### Bibcock

It is commonly referred to as the tap or faucet and it is the most frequently used water supply fitting. There are taps and faucets of many designs available in the market. While repairing, it is also advisable to read the manufacturers' instructions.

The defects commonly encountered in the functioning of taps and faucets, its causes and remedial measures to be taken are listed below.

### Defects

1. Water drips from the tap even when it is tightly closed
2. Water flows from around the spindle or stuffing box
3. Difficulty to turn on or off the tap
4. The spindle slips continuously when the tap is turned on and off.
5. There is a lot of noise in the tap when turned on.

### Causes

1. Worn out or defective washer
2. Accumulation of grit (small, loose particles of stone or sand), dust or other foreign matter
3. Defective seating
4. Gland nut (a component of the tap or faucet) is loose
5. The packing in the stuffing box is defective.
6. The packing in the stuffing box is dry.
7. The spindle is bent.
8. The spindle thread is worn out.

### Repair

1. Close the water supply to the water tap or bibcock.
2. With the help of a vice grip, hold the body of the bibcock.

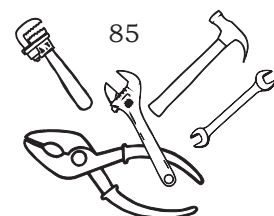

## NOTES

3. Use the wrench to remove the head of the tap by simply tapping.
4. Check the spindle; if it is worn out, replace it.
5. Remove the old washer of the spindle.
6. Replace with a new washer.
7. Fit the head back to the body.
8. Open the water supply and check the leakage, if any.

### Stopcock (stop tap or stop valve)

It is similar in construction to a bibcock, except that it is placed in the pipeline instead of the outlet. The defects commonly encountered during the functioning of stopcock, its causes and remedial measures to be taken, are listed below.

#### **Defects**

1. Water drips from the stopcock even after it is firmly closed
2. Water flows from around the spindle or stuffing box screw
3. It is difficult to turn on or tune off the stopcock.
4. The spindle slips down continuously when the stopcock is turned and the tap does not close.

#### **Causes**

1. Worn out or defective washer
2. Accumulation of grit, dust, or other foreign matter
3. Defective stopcock seat.
4. The gland nut is loose.
5. The packing in the stuffing box is defective.
6. The packing in the stuffing box is dry.
7. The spindle is bent.
8. The spindle thread is worn out.

#### **Repair of a leaking stop tap joints**

First, we have to find exactly where the stop valve or tap is leaking. Mostly, there could be three possible places

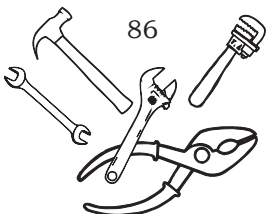



where a stop tap may leak.

1. Compression nuts
2. Gland nut
3. Head gear joint

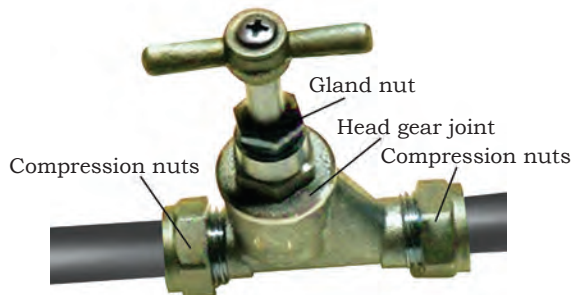

Fig. 6.1: Parts of a stop tap/valve



Fig. 6.2: Opening of a compression nut

**Compression nuts:** If water is leaking from one of the two compression nuts, then tighten the nuts and this should stop the leakage. Grip the body of the tap with water pump pliers and then tighten the nut by turning it clockwise, using a spanner.

If leakage does not stop, then wrap some polytetrafluoroethylene (PTFE) tape (Teflon or plumber's tape) around the nut. Prior to repairing, the water supply should be stopped.

Once this is done, you can loosen the nut by turning it anti-clockwise. Wrap some PTFE tape around the nut and then re-tighten the nut.

**Gland nut:** If the leak is on the gland nut, first try tightening the gland nut with a spanner. This may stop the water from leaking (Fig. 6.3).

The gland nut can be removed and repacked without the water being isolated. It is advisable to use two suitable spanners, one to hold the large nut on the stop tap and one to undo the gland nut. The nut will undo in an anti-clockwise direction.

Slide the gland nut up the spindle and then remove any old bits of packing from the gland. If the leak is on the head gear joint, we have to stop the water and then undo the nut and apply some PTFE tape to the threads (Fig. 6.4).



Fig. 6.3: Tightening of a gland nut



Fig. 6.4: Removing bits from a gland nut



(a) Opening of a large nut

(b) Separating body of a tap

Fig. 6.5 (a, b)

### Replacing stop tap washer

If water is still leaking through the tap then it is possible that it is worn out or damaged. Replace the washer in the following manner.

1. First stop the water supply to the tap (Fig. 6.5a).
2. Grip the body of the stop tap with a pair of adjustable water pump pliers. Then, with a suitable spanner, turn the large nut in the centre of the stop tap anti-clockwise (Fig. 6.5b).



Fig. 6.6: Checking the washer



Fig. 6.7: Removing the washer



Fig. 6.8: Replacing the rubber washer

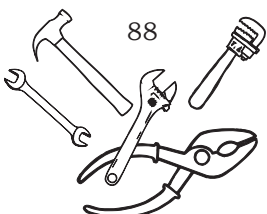

Fig. 6.9: Applying tape



Fig. 6.10: Assembly attached to the stop tap

3. Then, unscrew the handle and assembly from the body of the tap (Fig. 6.6).
4. Now remove the rubber washer at the end of the assembly (Fig. 6.7).
5. Replace the rubber washer with a new one. This simply pushes onto the end of the assembly (Fig. 6.8).
6. Wrap some PTFE tape around the thread of the assembly (Fig. 6.9).
7. Screw the assembly into the body of the stop tap and re-tighten using the water pump pliers and suitable spanner (Fig. 6.10).



## Water supply fitting-gate valve

Gate valve is one of the most common valves used in the main supply lines of a water supply system and pump-lines. The commonly encountered defects during the operation of gate valves, their causes and remedial measures to be taken are listed below.

### **Defects**

1. Water flows from around the stuffing box screw
2. The valve is hard to turn on or turn off.
3. The spindle rotates continuously and the gate valve does not close.

### **Causes**

1. The gland nut is loose.
2. The packing in the gland nut is defective.
3. The spindle is bent.
4. The spindle thread is worn out.

### **Repair**

1. Tighten the dry gland nut.
2. Renew the defective packaging with asbestos hemp and water pump grease.
3. Replace the bent spindle with a fresh one.
4. Replace the worn-out spindle.

## Cistern

### **Repair of cistern**

As you know, water is stored in the cistern, and if there is leakage in the cistern, the following steps should be followed for repairing.

*1. Inspect the toilet:* If water is not flushing, it means the flush is defective. It may have broken connection between the flush handle and the flushing mechanism. Remove the cistern lid and carefully set it aside so that it is not at risk of being stepped on by any person. Check all components and find the defective portion.

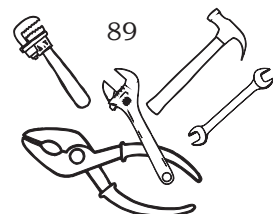



Fig. 6.11 (a, b) Cistern

2. *Repair the handle:* Sometimes, in the toilet cistern, the flush handle is loose and not connected to the other part. It may be due to a worn out connector. Thus, the handle gets dropped. We have to replace the damaged connector. With the help of a wrench, open the nut holding and remove the handle stem from the cistern and replace it with the same specification of handle stem. After undertaking the repair work, test the flush while the lid remains off to make sure it works properly.

3. *Replace the toilet siphon:* If the toilet cistern flush handle is intact and working properly, the problem is likely to lie with the flush diaphragm which is at the base of the toilet siphon. Toilet siphon is the largest section of the mechanism within the toilet in which water is drawn in and flushed out.

Disconnect the water supply to the toilet and flush out the water until the cistern is empty. Once empty, locate the clips that hold the flush handle to the siphon and the siphon to the rear of the cistern. The entire mechanism can then be lifted out of the cistern and see all components. The entire toilet mechanisms are available in the local market and can be purchased in a kit. Kit consists of all the components needed for replacement. Reassembling the mechanism is simply reversing the procedure used to disassemble it. After reconnecting all the fasteners and components, turn the water supply back on and check the cistern by refilling the water. See if it is working properly.

### ***Repair of float valve***

The float valve is used to stop the level of water in the water tank or cistern of the toilet tank.

1. Open the tank.
2. Check the parts of the float valve.
3. If the floating ball is punctured, replace with a new ball.
4. If the rod of float ball is bent, then straighten it or replace it.
5. Adjust the level of the float ball for water level.
6. Check and test with off and on switch.

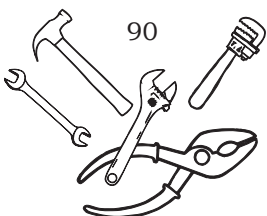

## Water closets

Most water closets are made of vitreous china which might crack if exposed to extremely hot water. A plunger will normally handle simple toilet clogs. Another method of cleaning a water closet trap or toilet is the use of an auger with an adjustable, crank-type handle. Known to plumbers as a 'snake', the spring steel coil is easily worked past the trap and down the pipe. A three foot auger is inexpensive and will quickly drill through most clogs. Use the auger carefully. Careless handling may crack the toilet.

## Toilet tanks

It is a general complaint that water continues to leak into the closet bowl of the toilet tank. It may be due to failure of mechanism of toilet tanks. Let us understand the possible reasons of water leakage.

One, when there is little humming noise or water continues to leak after filling the water tank, it means that there is leakage from the water tank. It may be due to improper placement of the flapper on the water discharge opening. Sometimes, the seat or collar of the discharge opening gets corroded due to sticking of dust, etc. To check the leakage of water, this corroded portion of the collar should be removed by rubbing with a file or scraper. Uniformity of collar will make uniform force on the stopper. Similarly, the wire of the float valve gets bent, leading to leakage of water. This wire should be straightened so that the ball is lifted properly and the water flow is stopped. Float valve should be regularly checked and it must be seen that it does not get shortened or punctured. If so, it should be immediately replaced. To check the overflow, a bent pipe is also inserted in the tank so that overflow of water is seen properly. Overflow pipe is generally kept 3/4" above the desired water level of tank. This will alert the user to check why water is getting lost, and take appropriate action.

## Fittings

You must have observed that taps, faucets and valves are important features of the plumbing system and are used mostly for all purposes. To increase the life of these

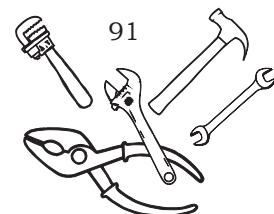

## NOTES

fittings, good quality material must be used. Generally chrome-plated brass fittings are mostly used for better quality and long life. These fittings can be easily cleaned with water and soap solutions.

It has been observed that metal chromium gets easily dissolved with the use of hydrochloric acid or sulphuric acid. Muriatic acid is effective for cleaning tiles where nickel-plated fittings are used. For chrome-plated fittings, cleaning of bathroom tiles should be done with oxalic acid. Acid fumes generated during the cleaning process also deteriorate the quality of fittings, despite being covered with clothes. Nowadays, polished brass-based fittings and trim are used mostly due to its better quality.

The use of solvent-based chemical solution should not be promoted for cleaning of tiles and fittings. It is generally suggested that manufacturer's recommendation regarding the maintenance of fittings should be adopted and followed.

### Taps and faucets

#### **Washerless taps and faucets**

These can be either single handle or the two handle type. In these, the control of water flow is done by a replaceable cartridge or arrangement of seals that allows water flow when the holes or ports are lined up in a proper configuration. Giving the handle an extra hard twist to stop water flow will be ineffective. This type of a tap or faucet does not use compression strength to stop water flow. However, when removing the stem, always check the seat inside the body of the tap and the brass ring that the washer grinds against. The tap or faucet seat can be worn or grooved, making the washer replacement ineffective within days. The washer and seat are the two parts of a compression type tap or faucet that receive the greatest amount of wear. Pad a smooth jawed wrench with a cloth, then, using the padded wrench, unscrew the large packing nut and turn out the tap stem. Then, with a screwdriver that fits the screw slot closely, remove the screw from the bottom of the stem and pry out the worn washer. Next, clean out the washer seat or compartment. When this

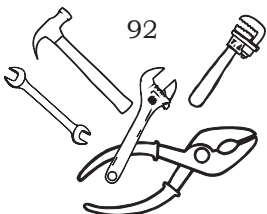

is done, insert the new washer of the correct size and composition for hot or cold water. Some of the newer, soft neoprene washers are for both hot and cold water and have a long life. The washer should fit snugly without having to be forced into position. After inserting, replace the screw and tighten. It is usually just as expensive to renew a seat as it is to buy a new tap, unless it has been made with renewable seat. Check with your plumber about a badly worn tap. With cloth over finger, clean the valve seat inside the tap or faucet. The edge should be smooth and free from deep nicks. If you find it badly worn, you will probably need to replace the seat or have the entire tap or faucet replaced by the plumber. Otherwise, it will leak again. Next, replace the tap or faucet stem and turn it in. Tighten the packing nut. Be careful not to tighten the nut more than necessary to stop seepage around the tap or faucet stem.

## Sink

Sink bowls come in many different materials. Although enamelled cast iron remains an attractive and durable product, many people today are choosing bowls made of stainless steel, and other solid surface materials for their added durability and stain resistance. The important thing to remember is to follow the manufacturer's instructions pertaining to the material of bowl. Use a non-abrasive cleaner. Constant use of abrasive cleaners can eventually wear the finish down, making it much more porous and susceptible to stains. This can also happen with enamelled, cast iron tubs over a long period.

## Washbasin

In our homes, washbasins and kitchen sinks get choked due to some obstruction from waste material or dirt. As a result, water can not flow smoothly. Thus, many small tools like plunger, auger, force cup and wire are used for clearing the obstruction.

## Noises in the plumbing system

In an old plumbing system, different types of noise may be created due to some defect. These could include whistling, chattering or hammering. Whistling is the



Fig. 6.12: Removing clogs in a washbasin

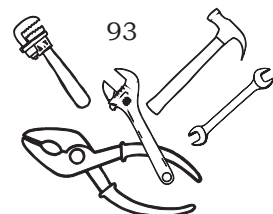



Fig. 6.13: Use of tools for removing clogs

most common noise heard in a plumbing system. It is created when water flows speedily through a pipe of a smaller diameter. It can be eliminated by inserting air pipe in the wall where supply wales enter the plumbing chambers. When water comes in contact with broken, loose pipes or pipes rubbing each other, a chattering noise is created. Due to sudden closing of tap or faucets, a thump in the water pipe is created which makes a hammering noise. These noises can be checked with proper intervention.

### Odours in the plumbing system

A well-designed and correctly installed plumbing system gives out no odour. Odours are most likely to arise from leaks in the waste or vent piping or from traps which have lost their water seal. In an incorrectly installed system, there is a possibility for odours to result from defects in the system, particularly if the fit is not properly vented.

### Repair of different types of pipes

Some of the methods of repair for different types of pipes are given in the following table.

Table 6.1: Different types of pipes and methods of repair

MATERIAL		CAST IRON
<b>Burst</b>	<b>Action</b>	<b>Repair</b>
Joint failure	Enclose joint Two couplers	Special joint clamp Two couplers and new section
Brittle failure	Remove section/joint Enclose failure	Two couplers and new section Repair collar or clamp
Corrosion	Remove section/joint Rehabilitation	Two couplers and new section Slipping, etc. Repair collar or clamp
MATERIAL		DUCTILE IRON
<b>Burst</b>	<b>Action</b>	<b>Repair</b>
Joint failure	Enclose joint Remove section/joint	Special joint clamp Two couplers and new section
Extensive pinholing	Rehabilitation technique Remove section/joint	Slipping, etc. Two couplers and new section
Ductile failure	Remove section/joint Enclose burst	Two couplers and new section Repair collar or clamp
Localised pinholing	Enclose burst	Repair collar or clamp

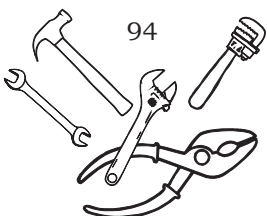



<b>MATERIAL</b>		<b>STEEL</b>
<b>Burst</b>	<b>Action</b>	<b>Repair</b>
Extensive pinholing	Rehabilitation technique Remove section/joint	Slip lining etc. Two couplers and new section
Joint failure	Remove section/joint Enclose joint	Two couplers and new section Special joint clamp
Isolated pinholing	Enclose burst	Patch and weld Repair collar or clamp
Isolated pinholing	Enclose burst	Patch and weld Repair collar or clamp
<b>MATERIAL</b>		<b>PRESTRESSED CONCRETE</b>
<b>Burst</b>	<b>Action</b>	<b>Repair</b>
Surface softening	Remove complete length/ joint Or cracking	Two couplers and new pipe section
Joint failure	Remove complete length/ joint Enclose joint	Two couplers and new pipe section Special joint clamp
<b>MATERIAL</b>		<b>POLYTHYLENE/P.V.C</b>
<b>Burst</b>	<b>Action</b>	<b>Repair</b>
Fast crack propagation	Remove damaged section	Two couplers and new section
Brittle failure	Remove damaged section Enclose burst	Two couplers and new section Repair collar or clamp
Joint failure	Cut out joint	Two couplers and new section

## **Plan and schedule routine maintenance, repairs and modifications**

1. As per the manufacturer's recommendation, check the need for repair, or replacement requirement of plumbing items.
2. Read the existing warranties and service agreements made by the user prior to start maintenance or repair work.
3. Prepare the estimate cost of the work to be done and collect a quotation if required.
4. Collect the written approval of the work to be carried out by the concerned person.

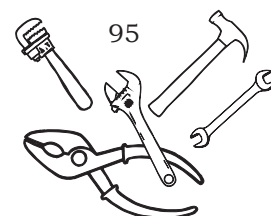

## NOTES

5. Detailed information of the site must be collected and check the requirement of access to the site.
6. Identify and select the labour, tools and machinery required for activities.
7. Qualification and skill experience of manpower should be properly checked.
8. Availability of labour should be scheduled as per need.
9. Availability of tools and equipment, machinery should be ensured as per work in advance so that work does not suffer.
10. Prior approval from the concerned department should be taken so that there is no further disturbance during work.
11. Plan appropriate time for installation so that minimum disturbance of operation occurs.
12. Detailed information of weather should be collected so that contingency planning can be done.
13. Mention in detail about the schedules, jobs to be carried out in work order, etc.
14. Submit the bill and final report of execution of work to the customer.

## Practical Exercises

### Activity 1

Change of washer in a bibcock

#### Material required

1. Bibcock
2. Washer
3. Screwdriver
4. Spanner
5. Pliers

#### Procedure

1. Select a bibcock.
2. Open its top cover with a screwdriver.
3. Open the nut with the help of a spanner and plier.
4. Take out the spindle.

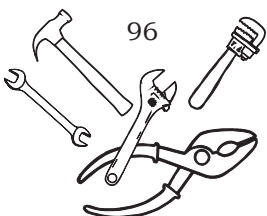

5. Remove the old washer.
6. Replace old washer with a new one.
7. Fix the spindle back and tighten with the help of a spanner and plier.
8. With the help of a screwdriver, tighten the spindle in the body and test it.

### Activity 2

Cleaning the blockage of a washbasin

#### Material required

1. Washbasin
2. Plunger
3. Snake wire

#### Procedure

1. Insert the snake wire in the hole of a washbasin.
2. With the help of a plunger, suck the dirty material.
3. Put water in the washbasin.
4. If water goes out smoothly, it means there is no blockage.

## Check Your Progress

### A. Explain the following

1. Why is repair necessary in the plumbing system?
2. List the defects and its causes in a bibcock
3. What could be the possible defects in a stopcock.
4. What are the reasons for noise in a plumbing system?
5. What are the reasons for odour in a plumbing system?
6. List the causes of damage to the plumbing pipeline.
7. What is the difference between wet repair and dry repair?

### B. Fill in the blanks

1. Water closets are made up of \_\_\_\_\_.
2. The three places where a stop tap may leak are \_\_\_\_\_, \_\_\_\_\_ and \_\_\_\_\_.
3. Wet repair is done when pressure in the pipe is \_\_\_\_\_.
4. Bibcock is commonly referred to as \_\_\_\_\_.
5. Gate valve is used for \_\_\_\_\_.

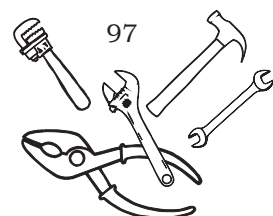

## ANSWER KEY

Unit	Multiple choice questions	Fill in the blanks	Full forms	Match the following
1.	1. (a) 2. (a) 3. (b) 4. (a)	—	1. Main Soil Pipe 2. Main Ventilating Pipe 3. Main Waste Pipe 4. Main Soil Waste Pipe	—
2.	1. (b) 2. (a) 3. (b) 4. (d)	1. Bench vice 2. hold, support 3. Mason's square 4. Drill machine	—	1. (b) 2. (d) 3. (a) 4. (c)
3.	1. (d) 2. (a) 3. (a) 4. (c) 5. (d)	1. Stationary 2. Noise 3. Demolition 4. Guards 5. potential	—	—
4.	1. (d) 2. (a) 3. (a) 4. (a)	1. 15 2. Brass 3. Beveling 4. Backflow	—	—
5.	1. (b) 2. (a) 3. (b) 4. (c)	1. Corrosion 2. stoppage 3. Magnesium 4. galvanised, copper	—	—
6.	—	1. vitreous china 2. Compression nuts, gland nuts and head gear joint 3. normal 4. tap 5. controlling the water supply	—	—